



# Piano Eliminazione Barriere Architettoniche

## ALLEGATO III

### PLANIMETRIE

- EDIFICI ■
- CENTRI SPORTIVI ■
- CIMITERI ■
- PARCHI ■

### TECNICO INCARICATO

Arch. Paolo Pasquali

### COLLABORATORI

Ing. Fabrizio Gamberoni

Ing. Fabio Bettinelli



Città di Castelleone

Piano Eliminazione **B**arriere **A**rchitettoniche – P.E.B.A.

AOO COMUNE DI CASTELLEONE  
Protocollo Arrivo N. 11273/2026 del 11-06-2026  
Allegato 3 - Class. 6.1 - Copia Del Documento Firmato Digitalmente

**SOMMARIO PLANIMETRIE EDIFICI, CENTRO SPORTIVO, PARCHI E CIMITERI**

SEDE MUNICIPALE – PIANO TERRA .....	5
SEDE MUNICIPALE – PIANO PRIMO .....	6
SEDE POLIZIA LOCALE .....	7
SEDE ASSOCIAZIONE ANTIQUARIA – PIANO TERRA .....	8
SEDE ASSOCIAZIONE ANTIQUARIA – PIANO PRIMO .....	9
SEDE SCUOLA INTAGLIO LEGNO – PIANO TERRA .....	10
SEDE SCUOLA INTAGLIO LEGNO– PIANO PRIMO .....	11
SERVIZI SOCIALI E GUARDIA MEDICA .....	12
SALA SOCIO-CULTURALE .....	13
MUSEO – PALAZZO BRUNENGGHI .....	14
BIBLIOTECA – PALAZZO BRUNENGGHI - PIANO TERRA.....	15
BIBLIOTECA – PALAZZO BRUNENGGHI - PIANO PRIMO.....	16
ASSOCIAZIONE REDUCI E COMBATTENTI – PALAZZO BRUNENGGHI.....	17
SALA CONFERENZE – PALAZZO BRUNENGGHI .....	18
ASSOCIAZIONE ALPINI – PALAZZO BRUNENGGHI - PIANO TERRA .....	19
ASSOCIAZIONE ALPINI – PALAZZO BRUNENGGHI - PIANO PRIMO.....	20
LOCALI IN DISUSO – PALAZZO BRUNENGGHI - PIANO TERRA.....	21
LOCALI IN DISUSO – PALAZZO BRUNENGGHI - PIANO PRIMO.....	22
LOCALI IN DISUSO – PALAZZO BRUNENGGHI - PIANO SECONDO.....	23
SEDE L.A.T.E. ex scuola materna piazza Trieste.....	24
TEATRO LEONE - PIANO TERRA.....	25
TEATRO LEONE - PIANO PRIMO.....	26
SEDE AVIS.....	27
CASERMA DEI CARABINIERI.....	28
SALA DELLA MUSICA.....	29
SEDE A.S.M.-PIANO TERRA.....	30
SEDE A.S.M.-PIANO PRIMO.....	31
ASILO NIDO .....	32
SCUOLA DELL’INFANZIA.....	33



SCUOLA PRIMARIA via BECCADELLO – PIANO TERRA.....	34
SCUOLA PRIMARIA via BECCADELLO – PIANO PRIMO.....	35
SCUOLA PRIMARIA via CAPPI – PIANO TERRA.....	36
SCUOLA PRIMARIA via CAPPI – PIANO PRIMO.....	37
SCUOLA SECONDARIA DI PRIMO GRADO – PIANO TERRA .....	38
SCUOLA SECONDARIA DI PRIMO GRADO – PIANO PRIMO .....	39
CENTRO SPORTIVO “DOSSO” - PLANIMETRIA GENERALE.....	40
CENTRO SPORTIVO “DOSSO” – PIANO TERRA .....	41
CENTRO SPORTIVO “RIBOLI”- PLANIMETRIA GENERALE.....	42
CENTRO SPORTIVO “RIBOLI” – PIANO TERRA .....	43
PALAZZETTO DELLO SPORT “PALADOSSO” – PIANO TERRA.....	44
PALAZZETTO DELLO SPORT “PALADOSSO” – PIANO PRIMO.....	45
PALESTRA via CAPPI.....	46
PISCINA COMUNALE.....	47
CIMITERO DI CASTELLEONE... ..	47
CIMITERO DI CORTE MADAMA .....	49
CIMITERO DI SAN LATINO.....	50
GIARDINI piazza DELLA VITTORIA – piazza TRIESTE.....	51
GIARDINO PUBBLICO VIA MURA MANFREDI.....	52
PARCO GIOCHI via PONCHIELLI.....	53
PARCO IN LOCALITA’ LE VALLI.....	54
PARCO via GRAMSCI.....	55
PARCO via BECCHETTO.....	56
PARCO OSVALDO MARCOTTI.....	57
PARCO via MATTEOTTI.....	58
PARCO via I MAGGIO.....	59
PARCO via FULCHERIA.....	60



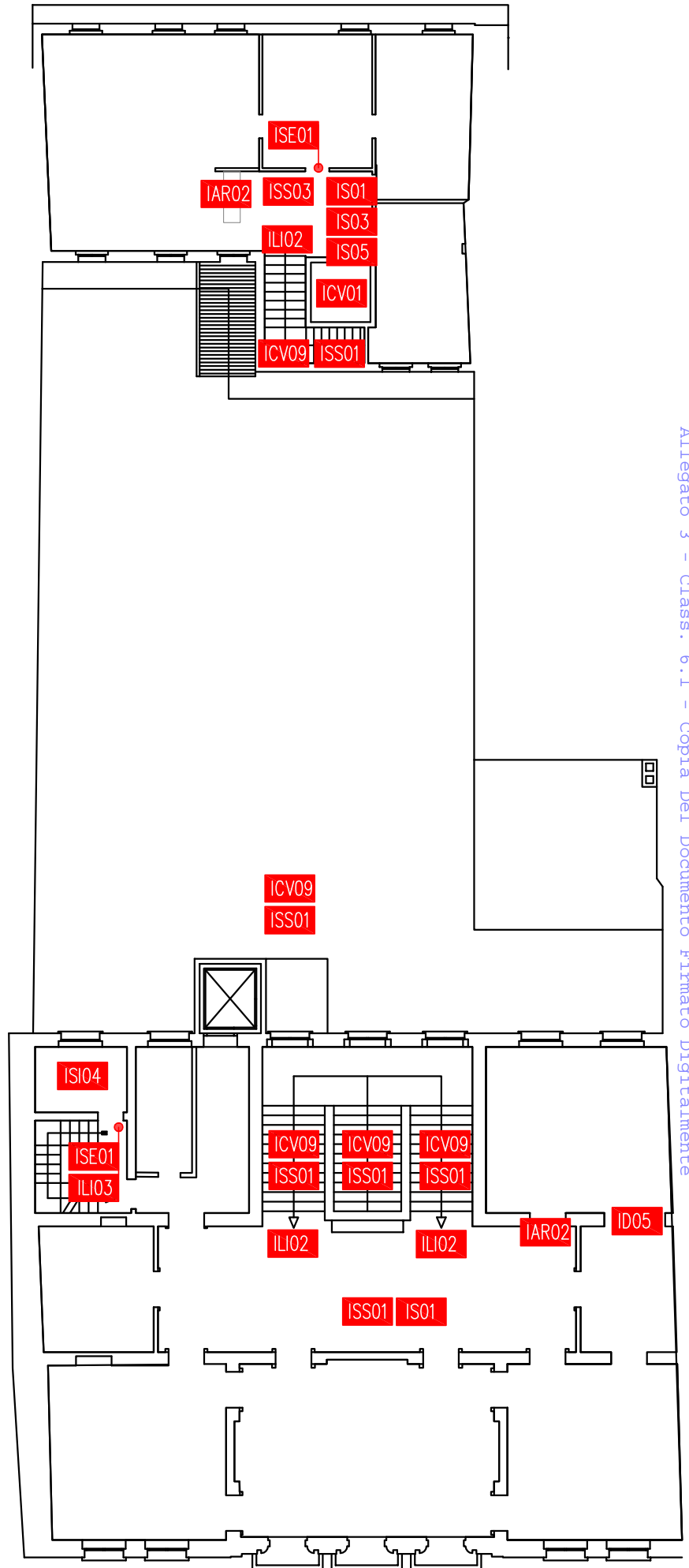

PRIMA

PR

POLIZIA LOCALE

PIANO TERRA

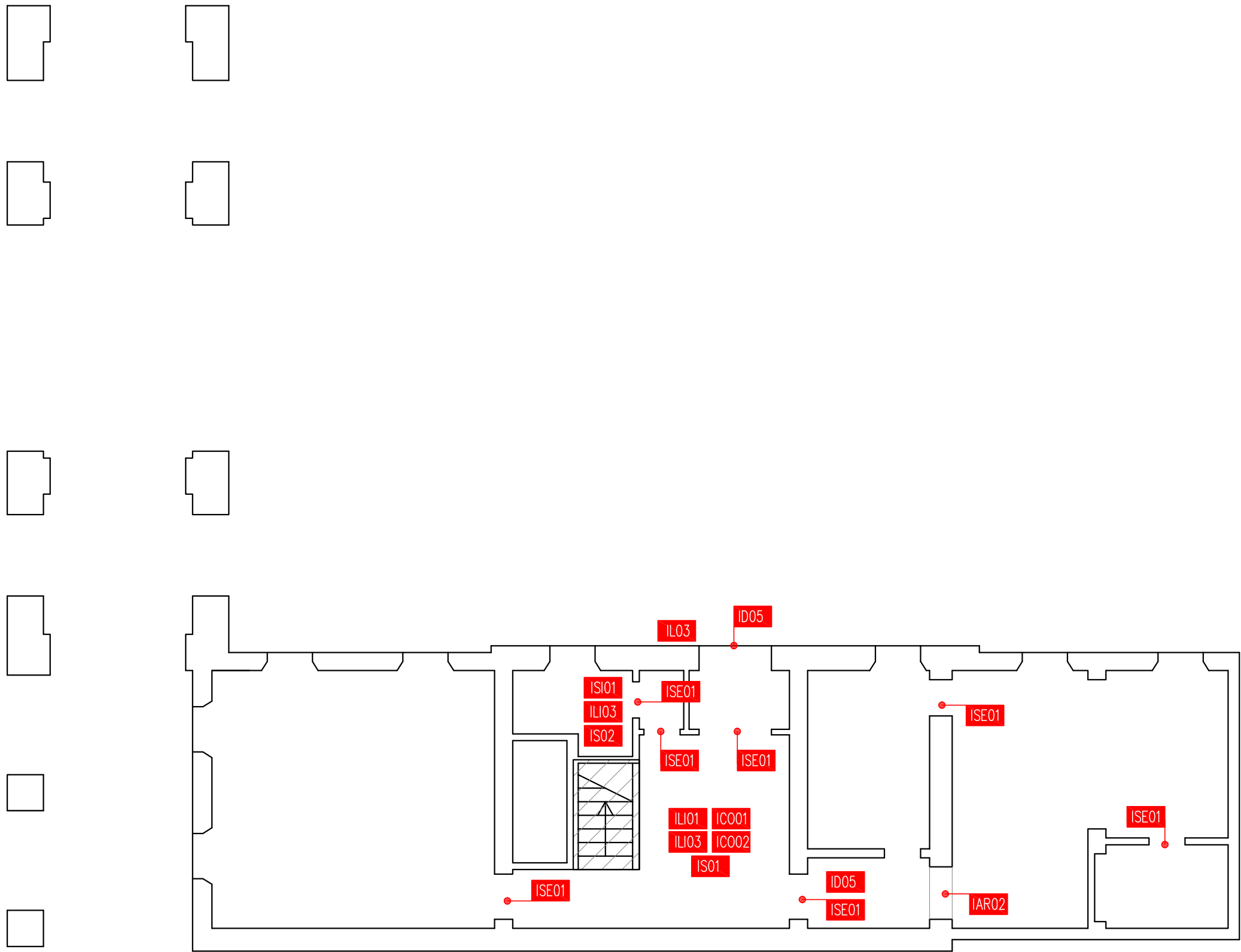

PER  
ABB  
A

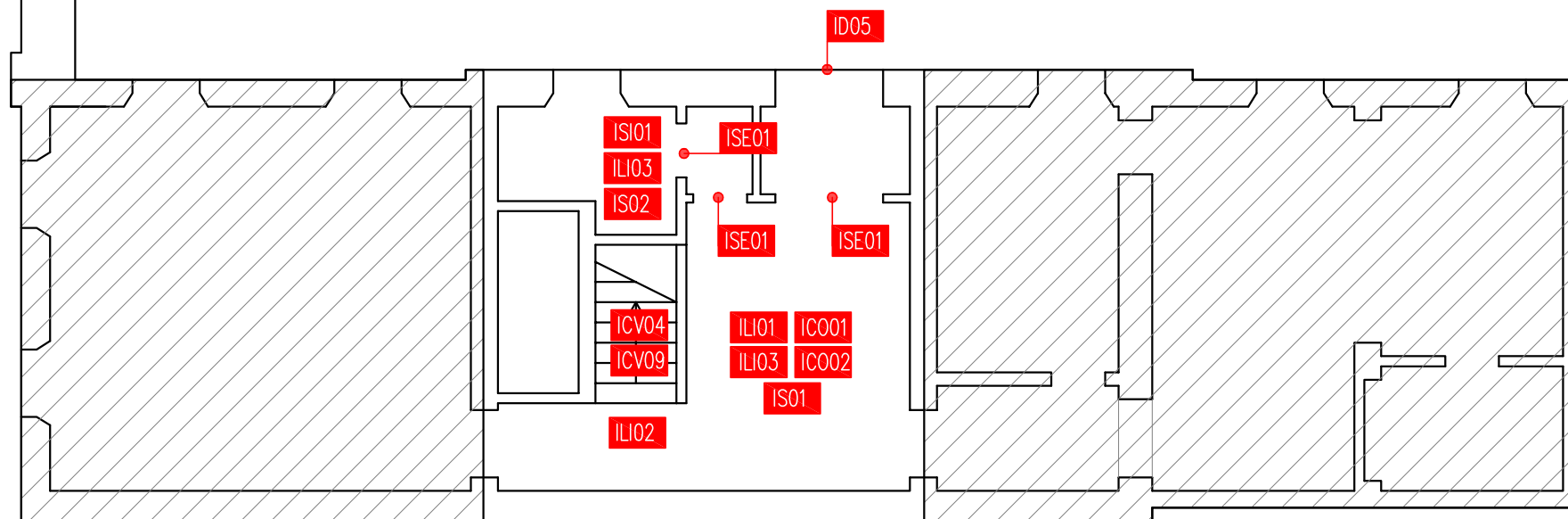
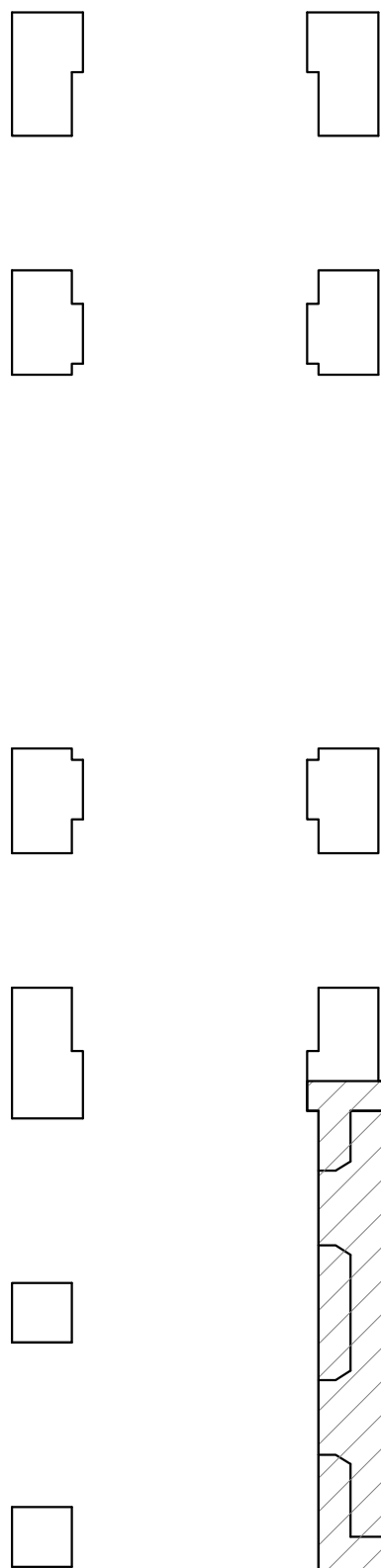

ISR04  
IL01

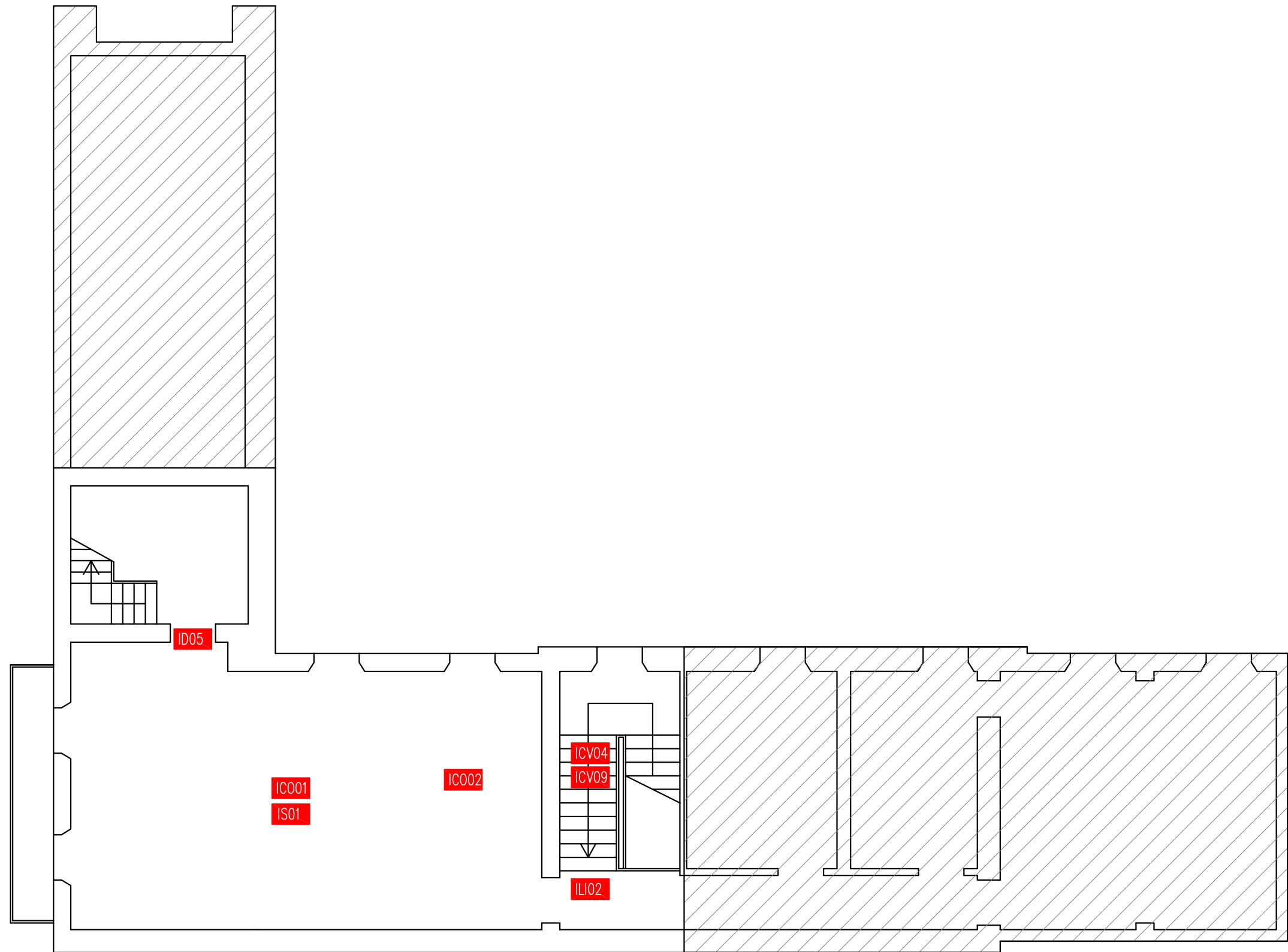

BBBA

PER  
ABB  
A

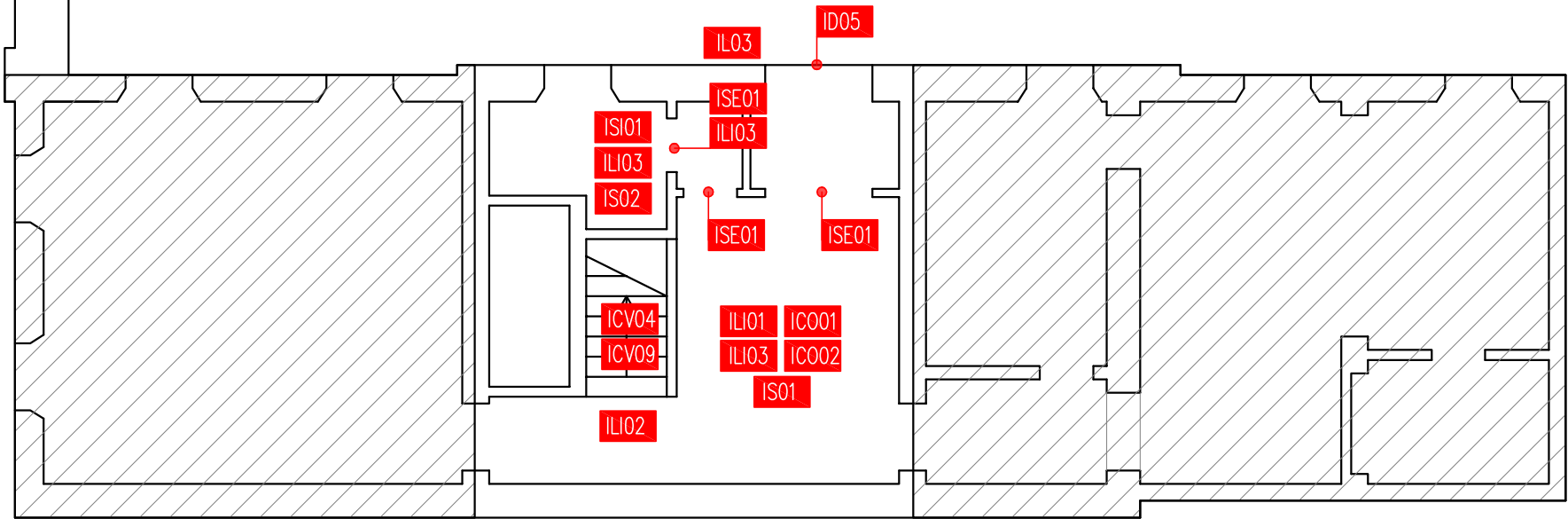
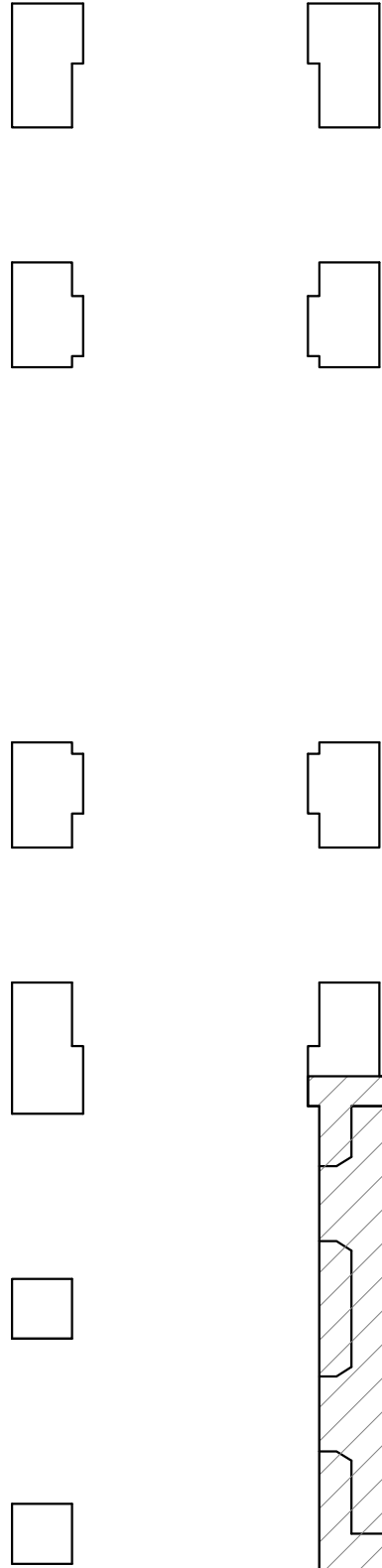

ISR04  
IL01

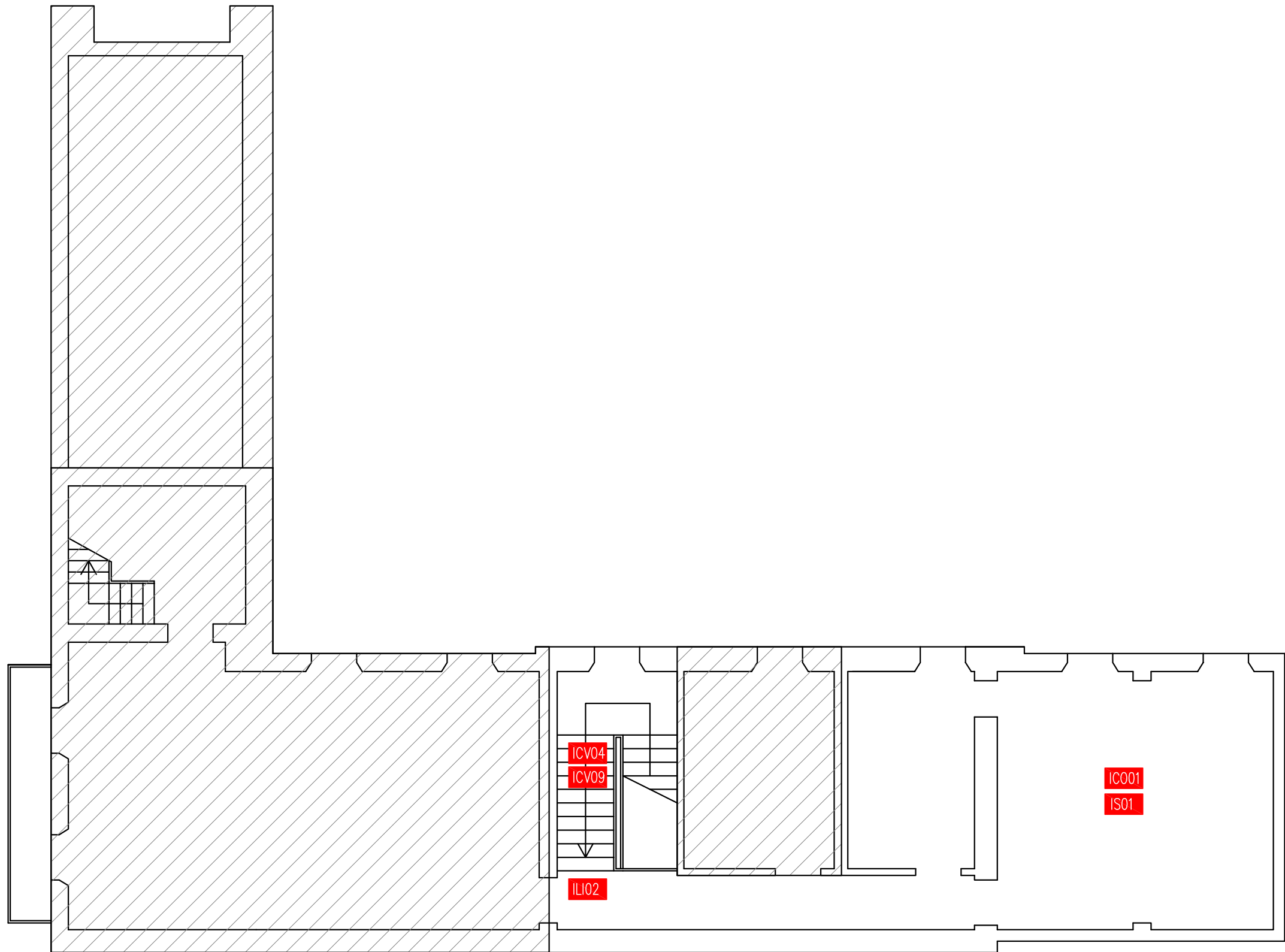

ARRETRATI

ISC01  
ID02

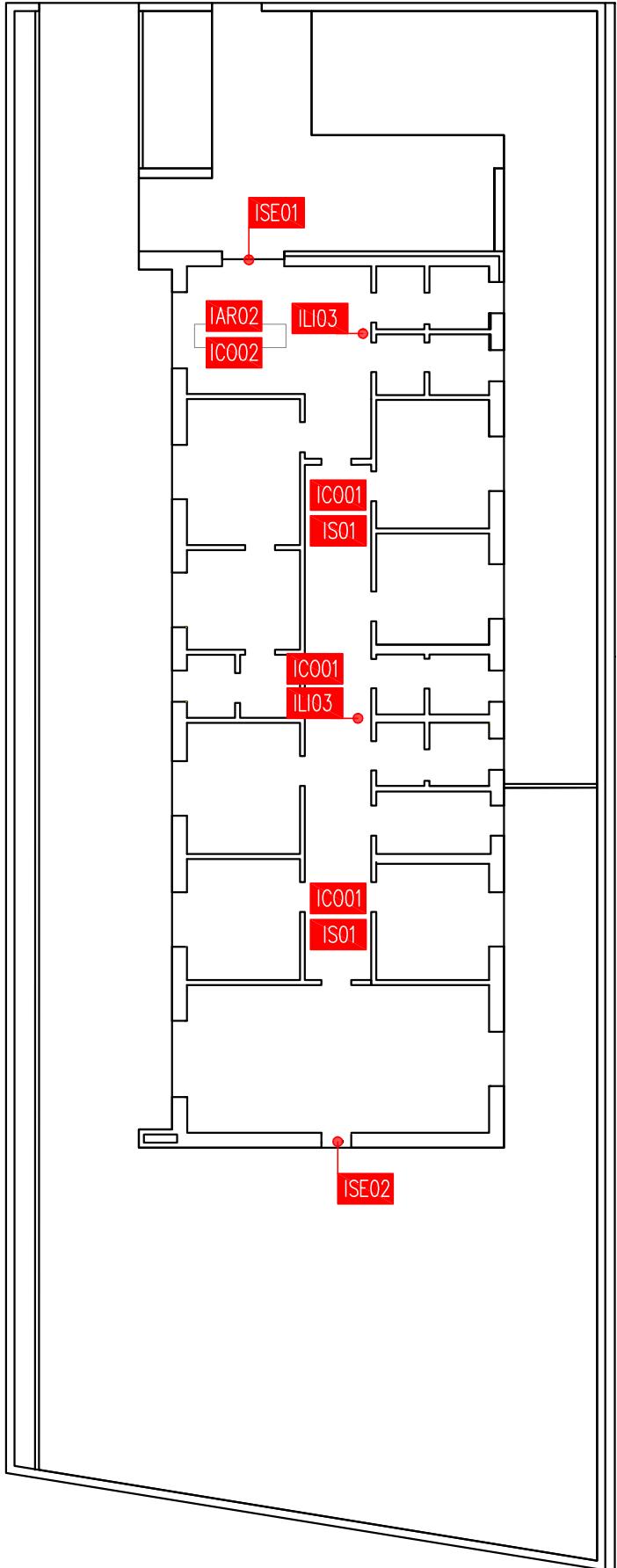

PARTE

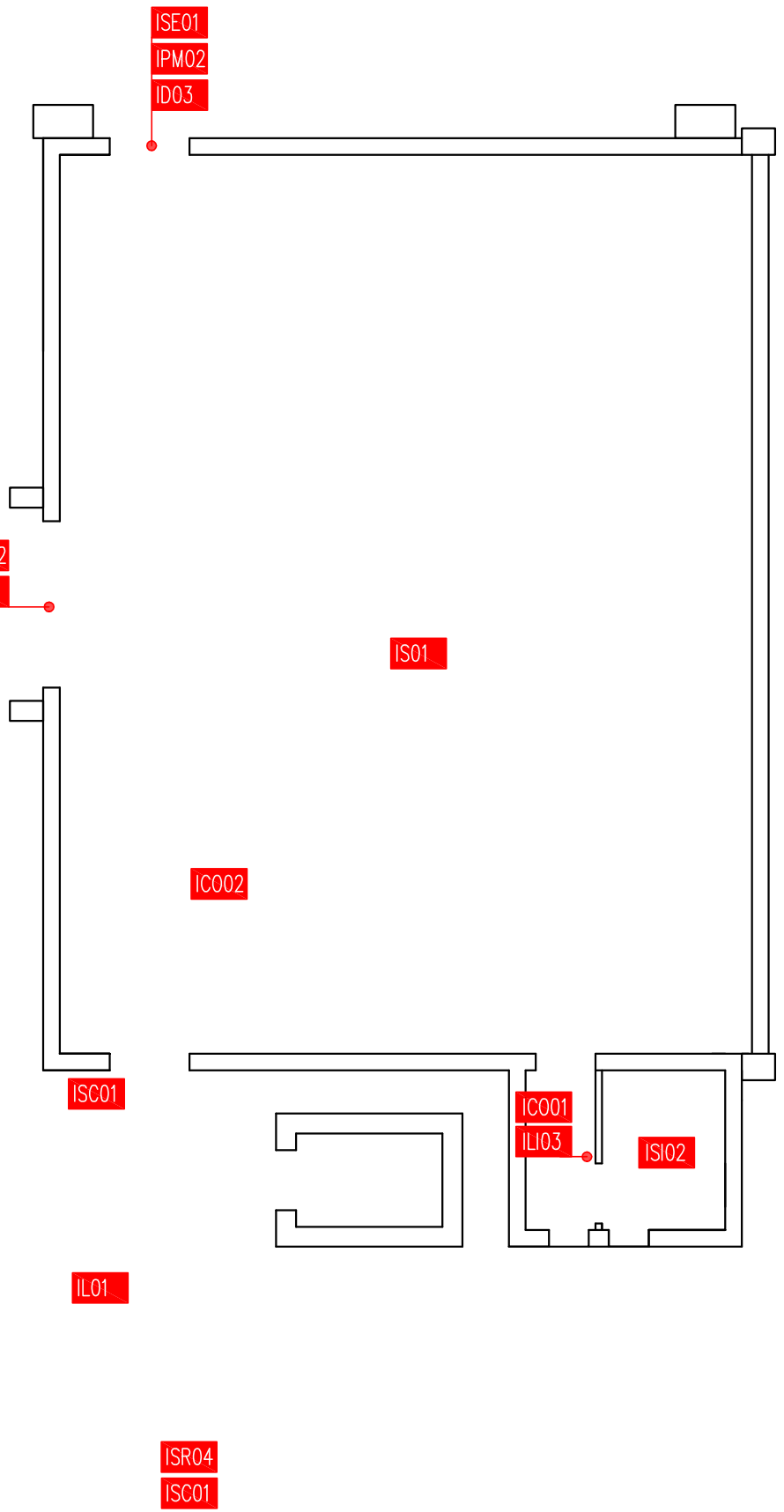

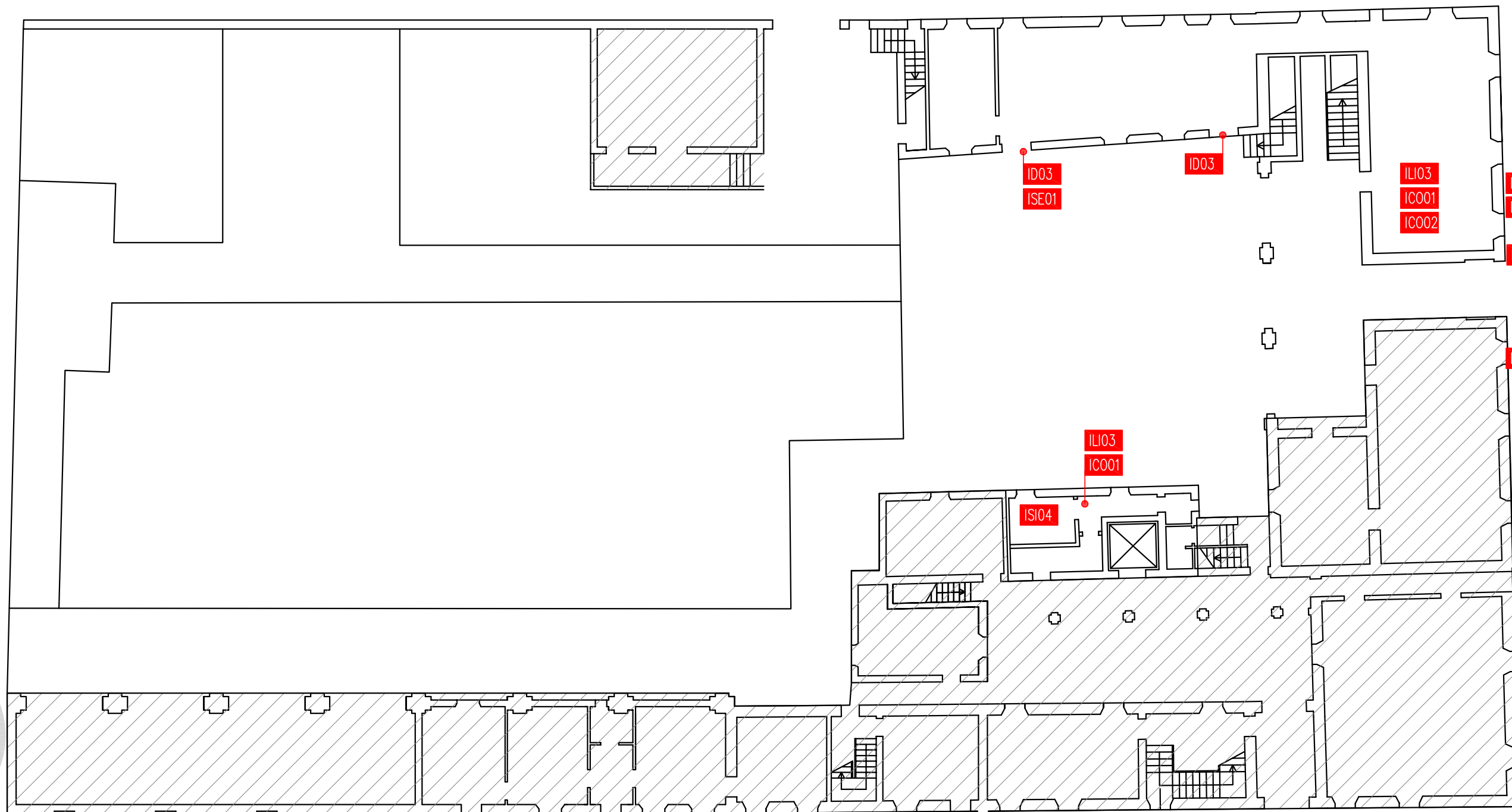

BRUNENGHI

AOO COMUNE DI CASTELLEONE  
Pot. Illo Arrivato  
Leg. o 3 - Clas  
11273/2026 del 11-06-2026  
6.1 - Copia Del Documento Firmato Digitalmente

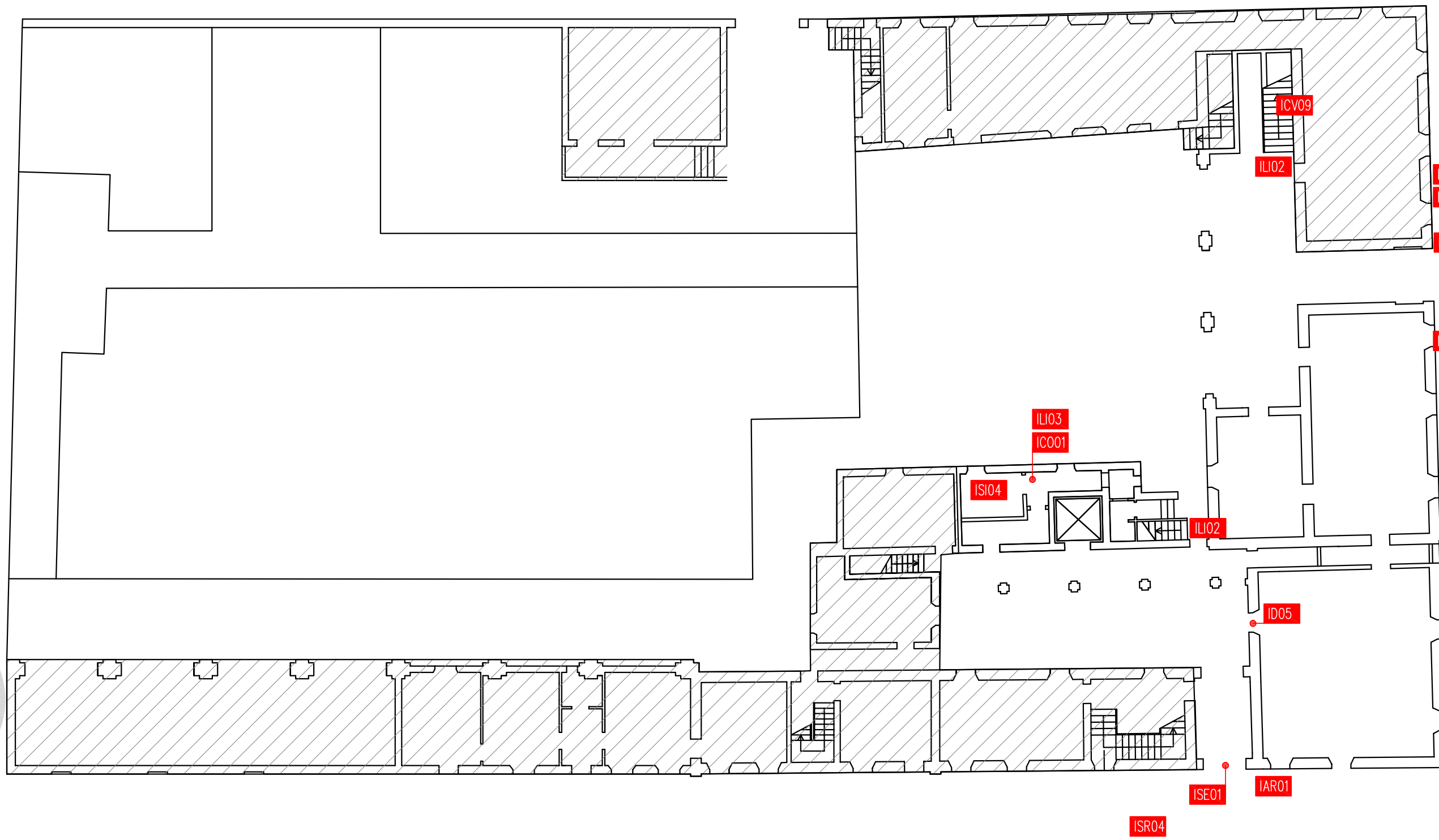

BIBLIOTECA

AOO COMUNE DI CASTELLEONE  
Pot. Illo Arrivato  
Leg. n. 3 - Class. 1273/2026 del 11-06-2026  
6.1 - Copia Del Documento Firmato Digitalmente

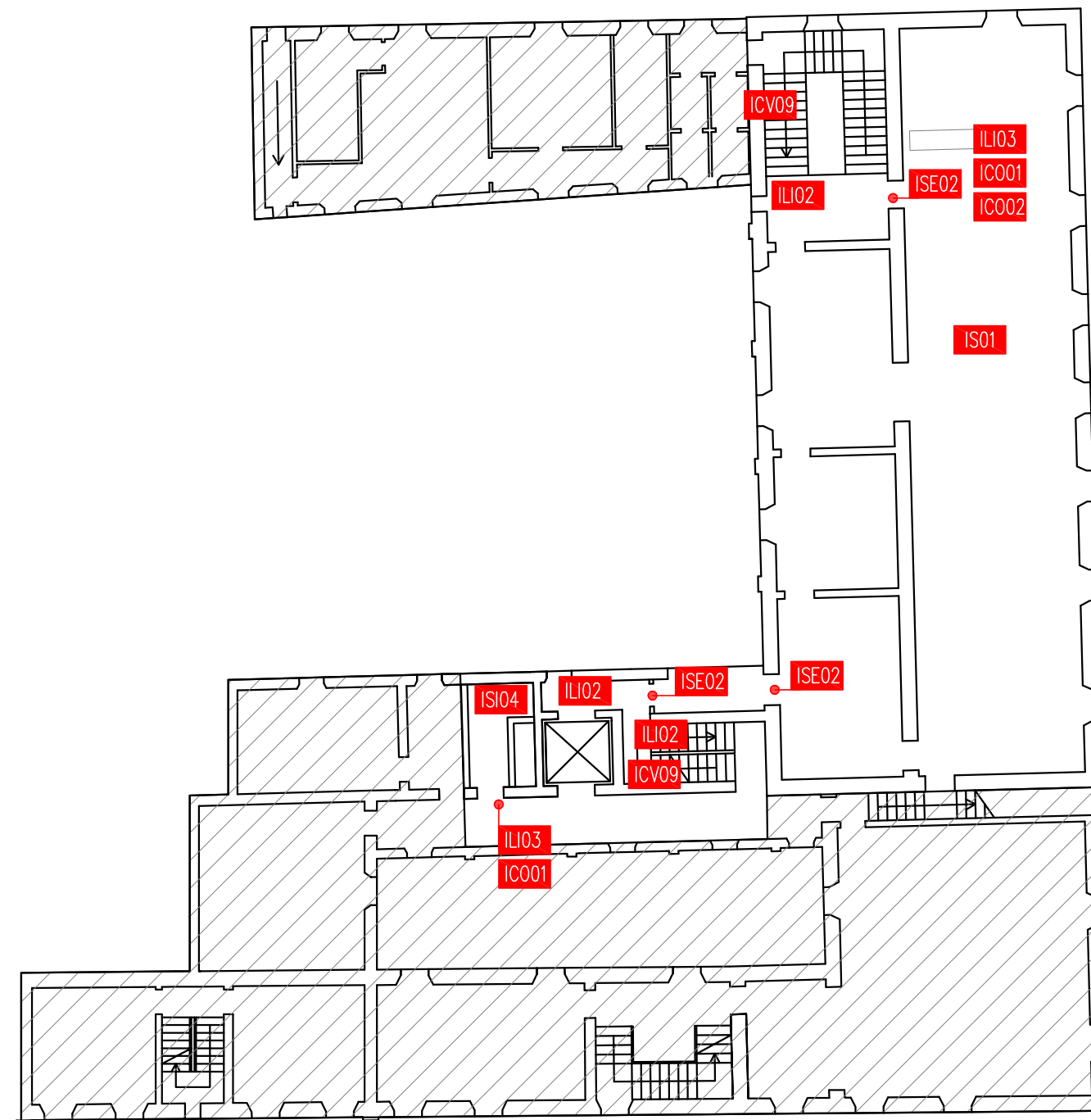

BBBA

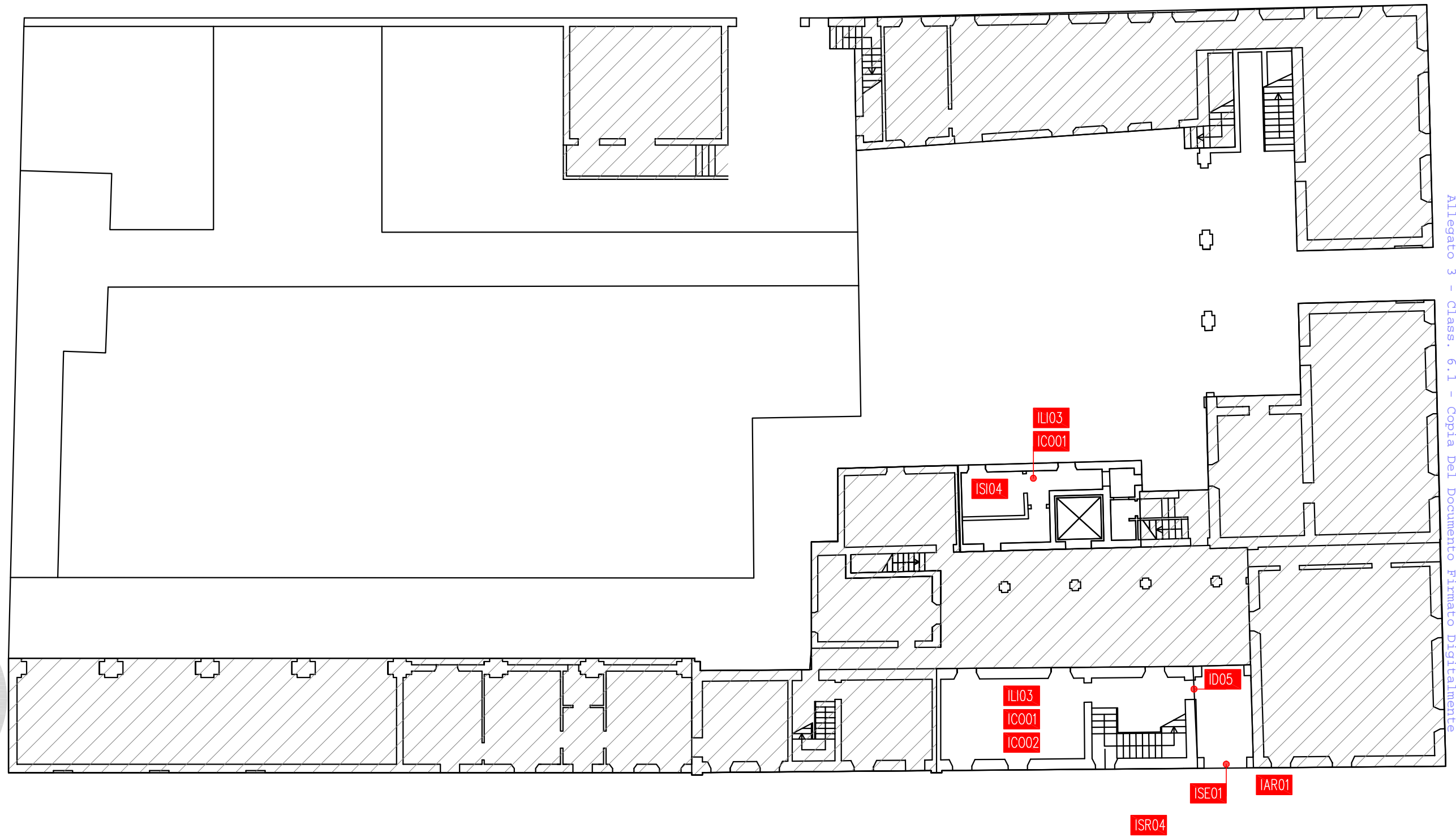

BRUNENGHI

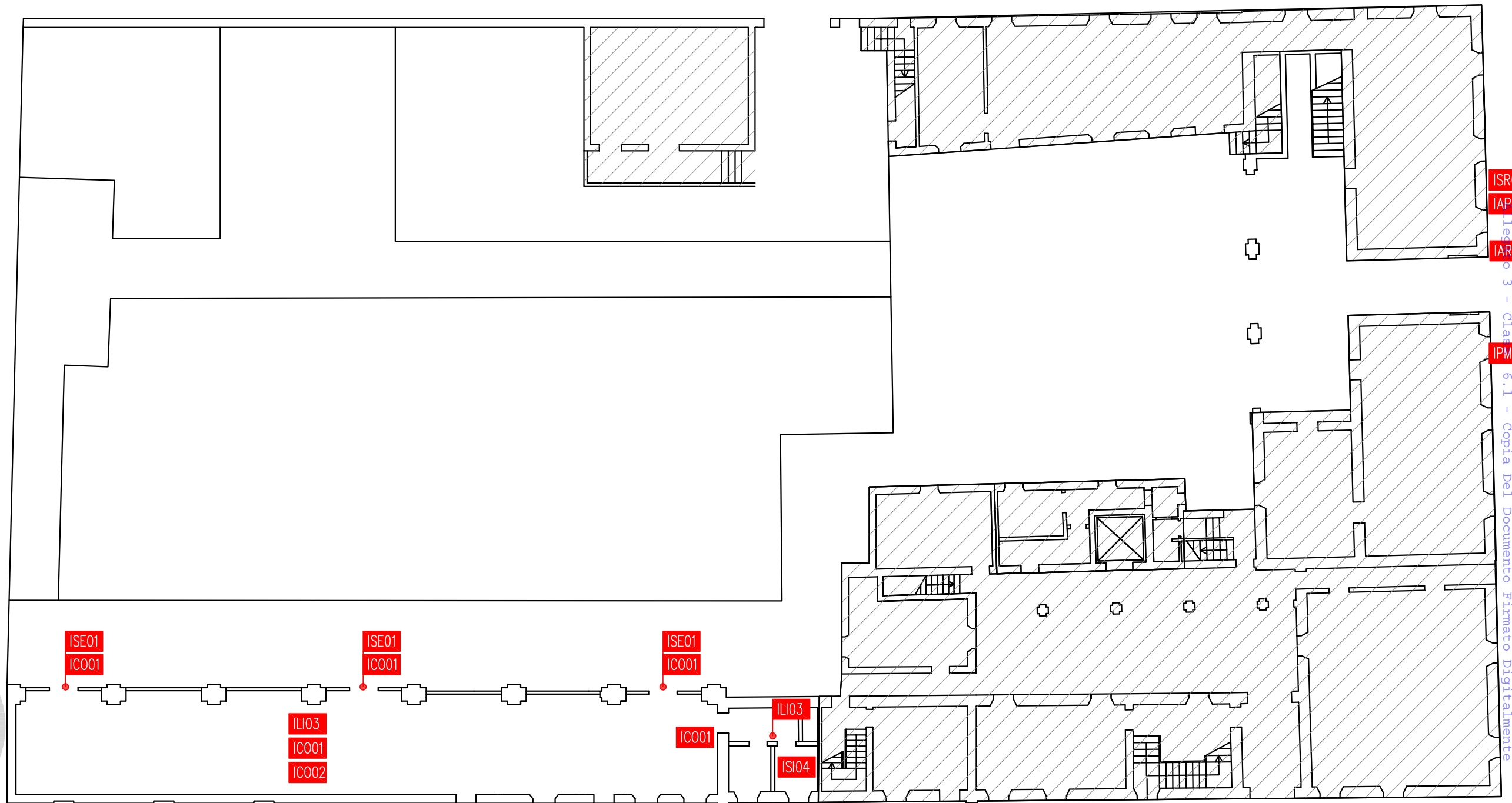

BRUNENGI

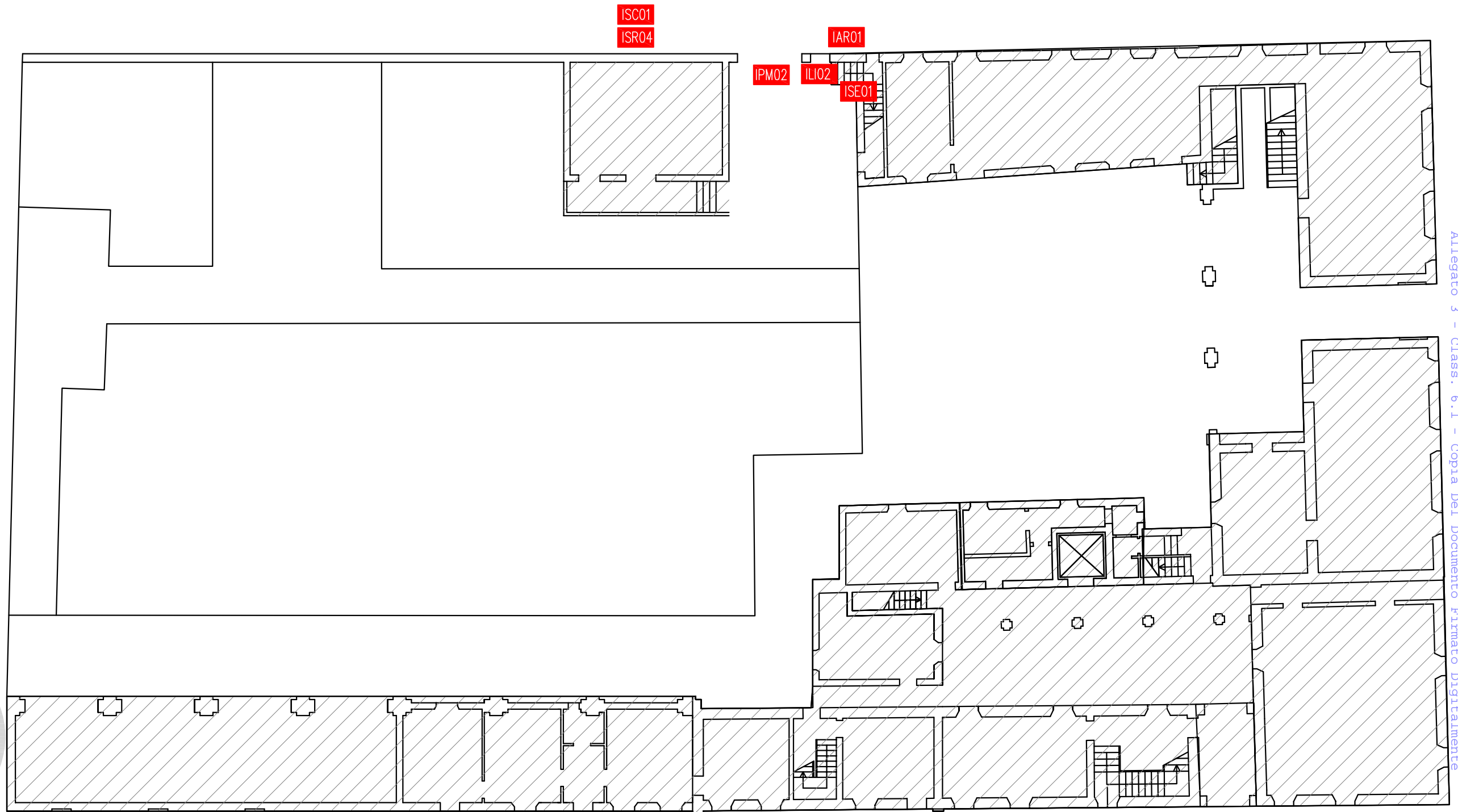

BRUNENGGHI

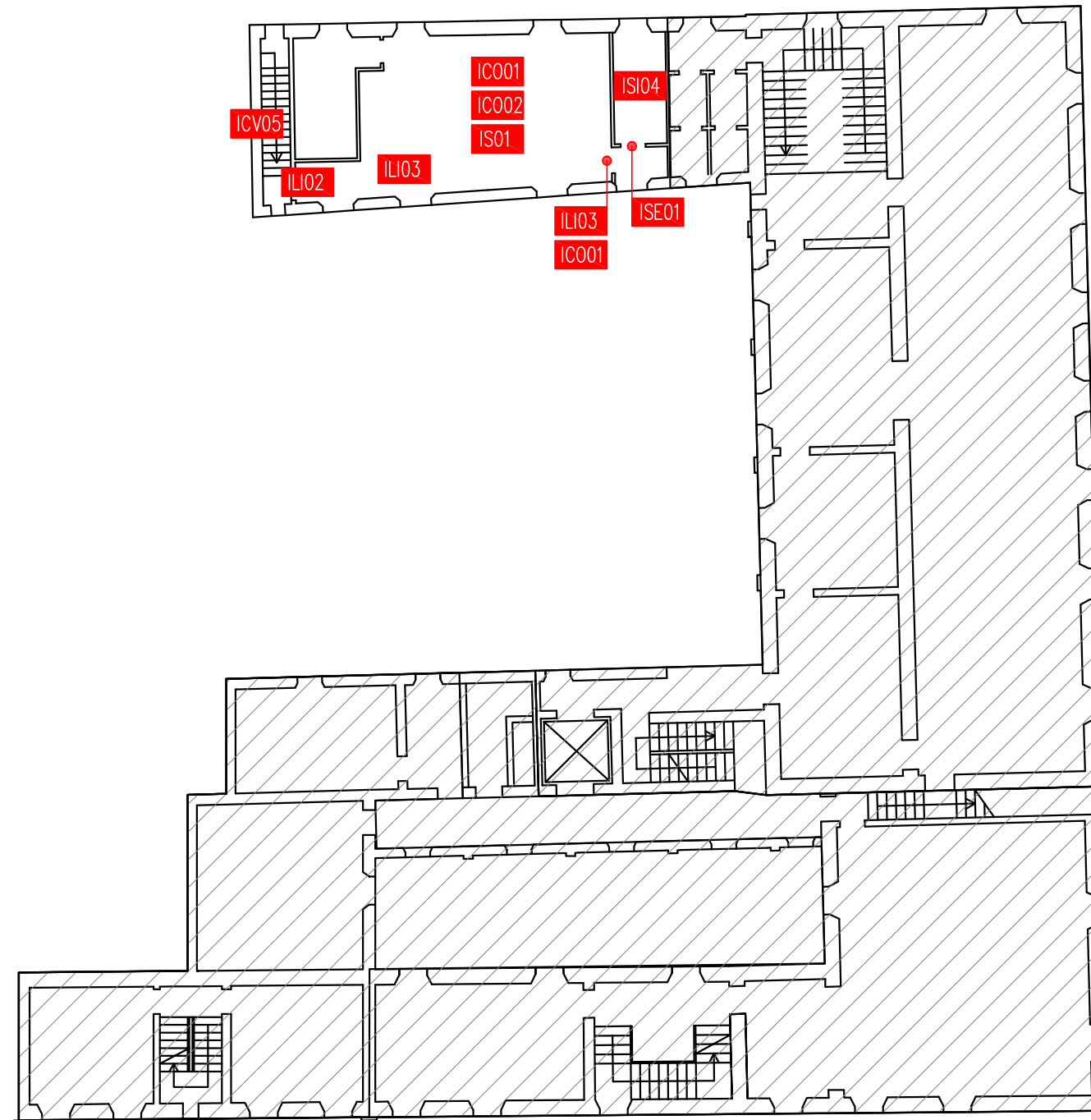

BBBA

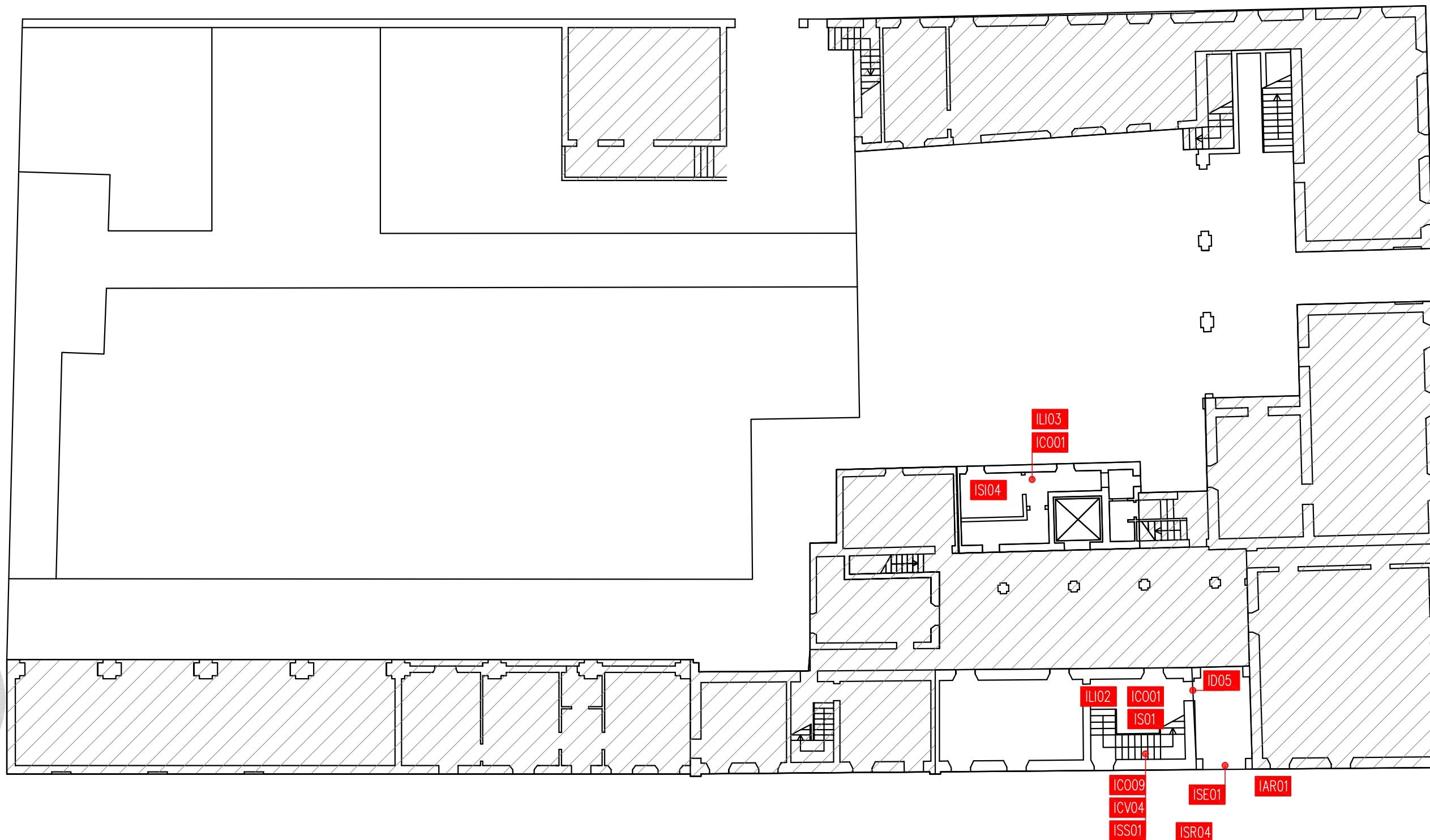

BRUNENGHI

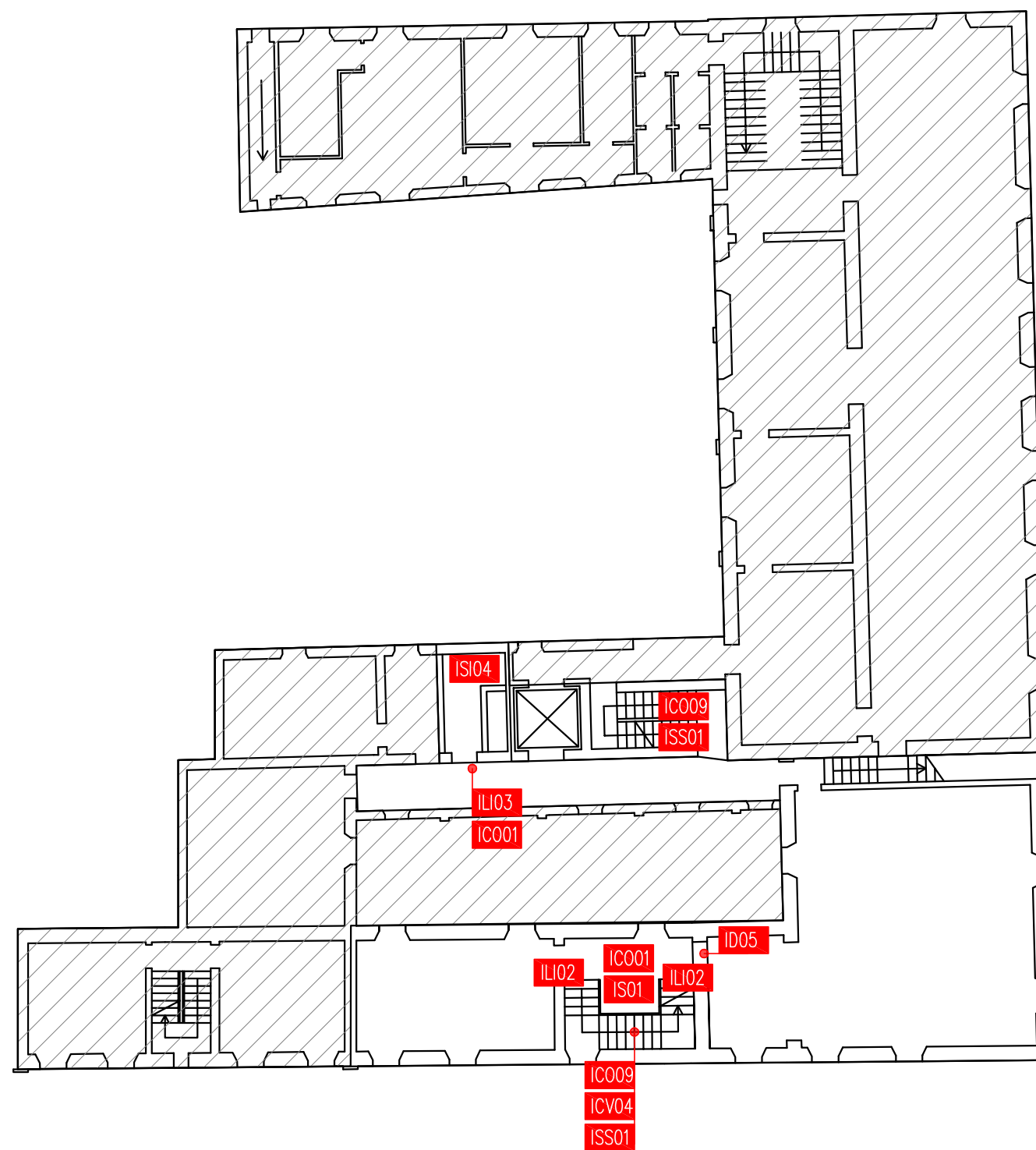

Palazzo Brunenghi

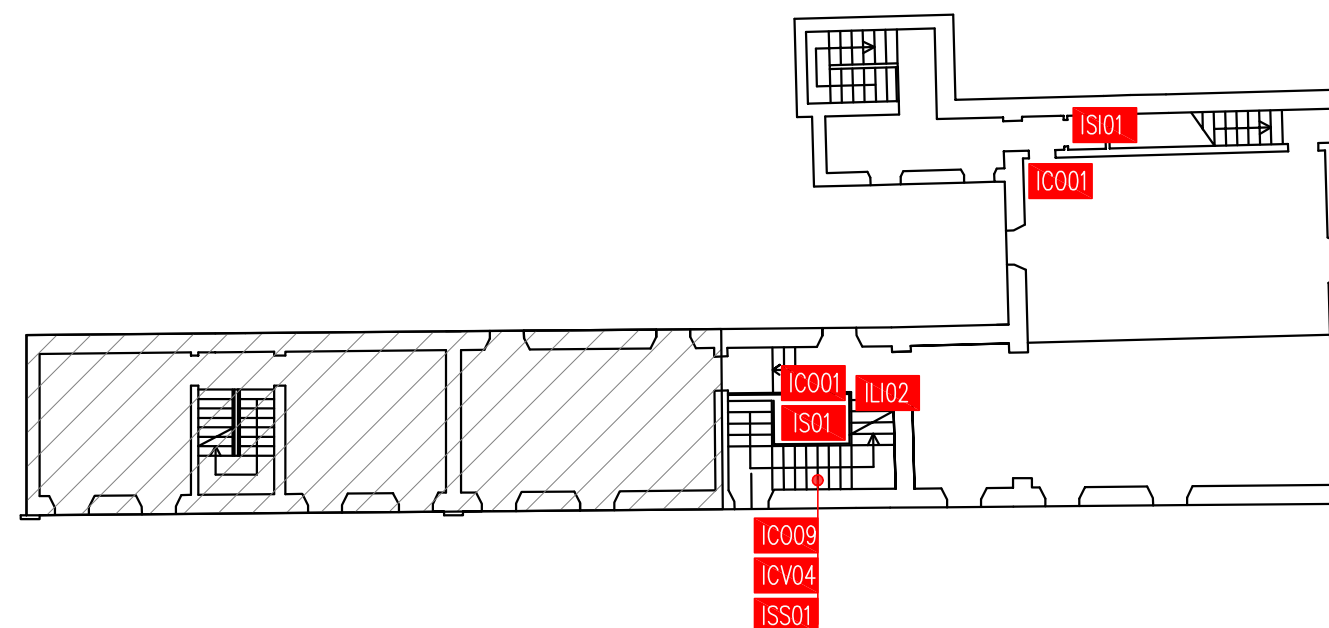

PAZZO BRUNENGHI



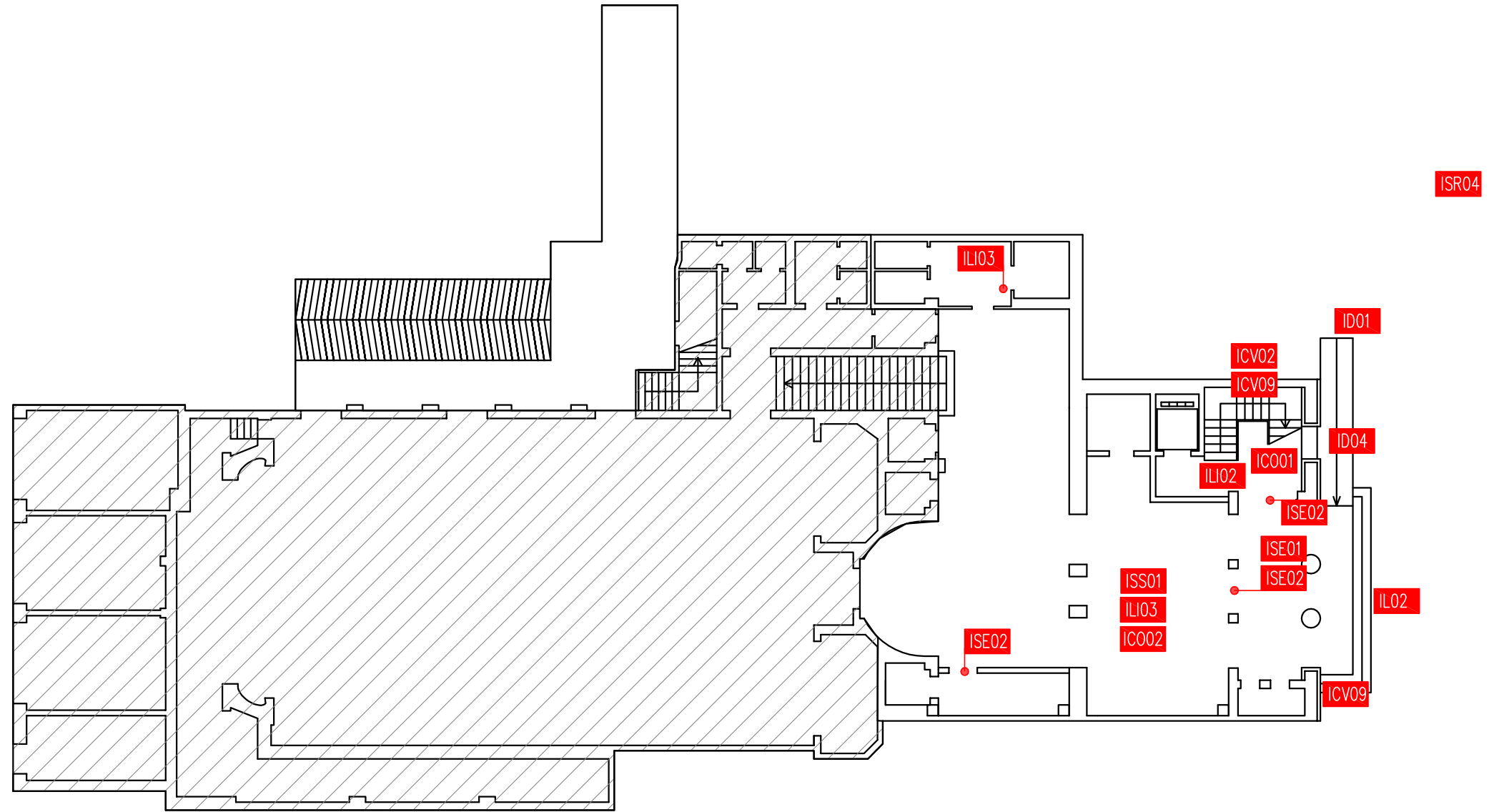

BBBA

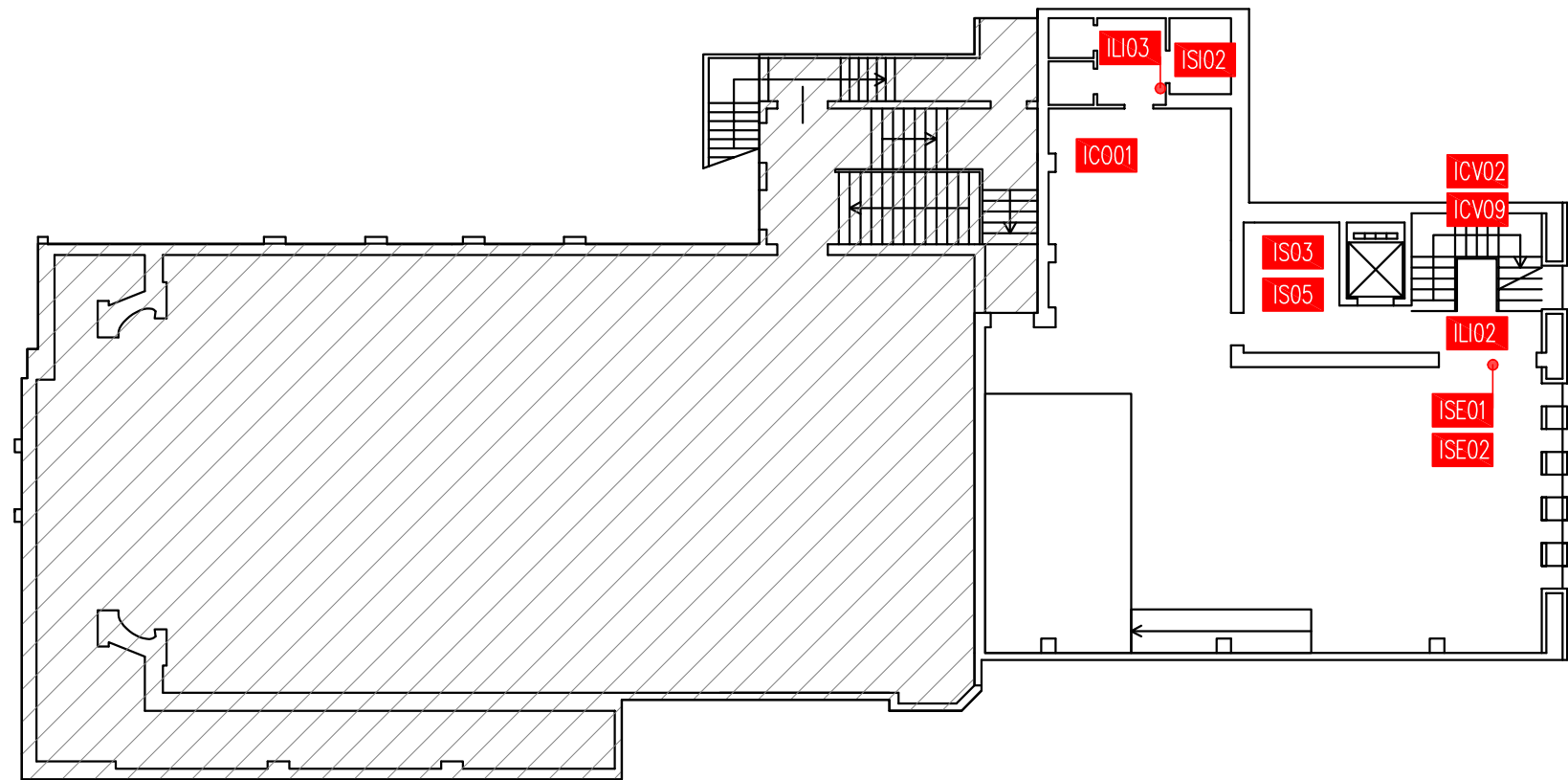

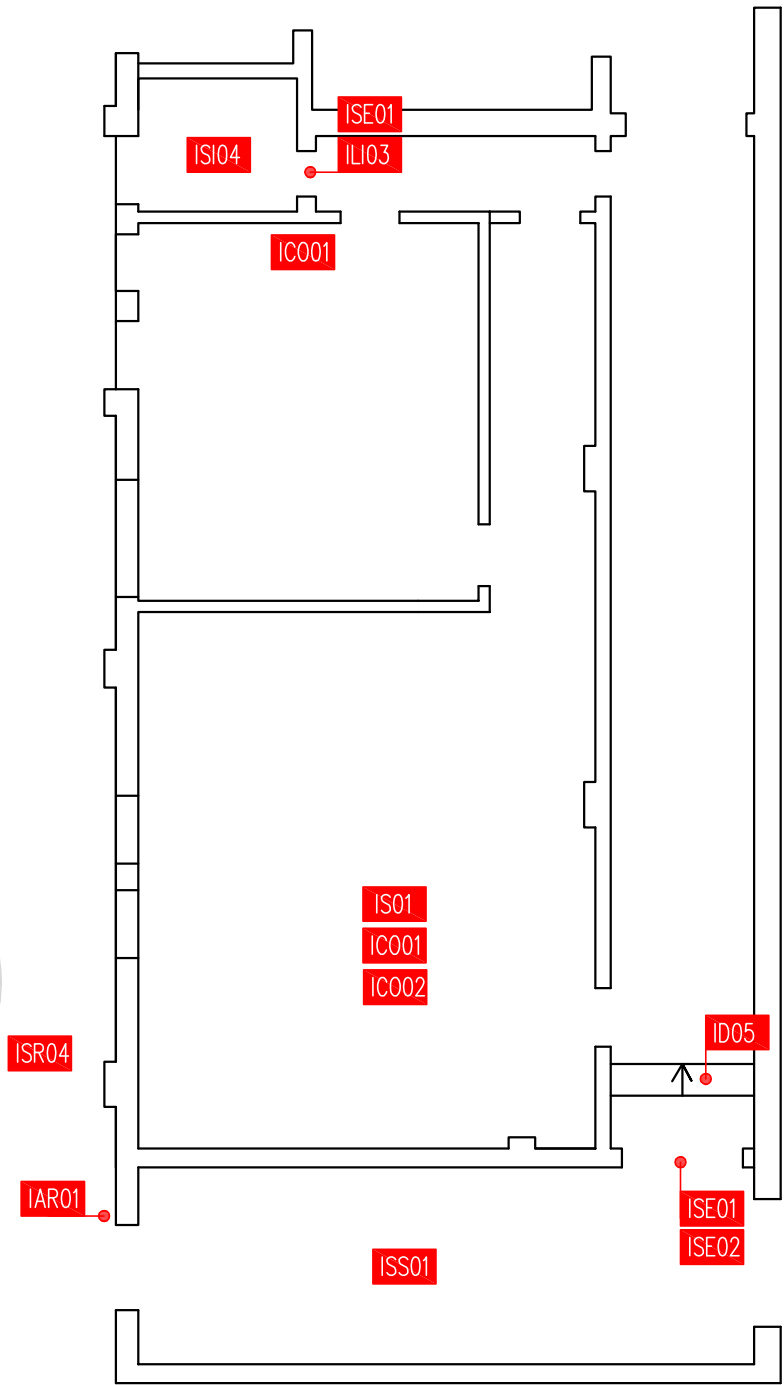

PROBABILE

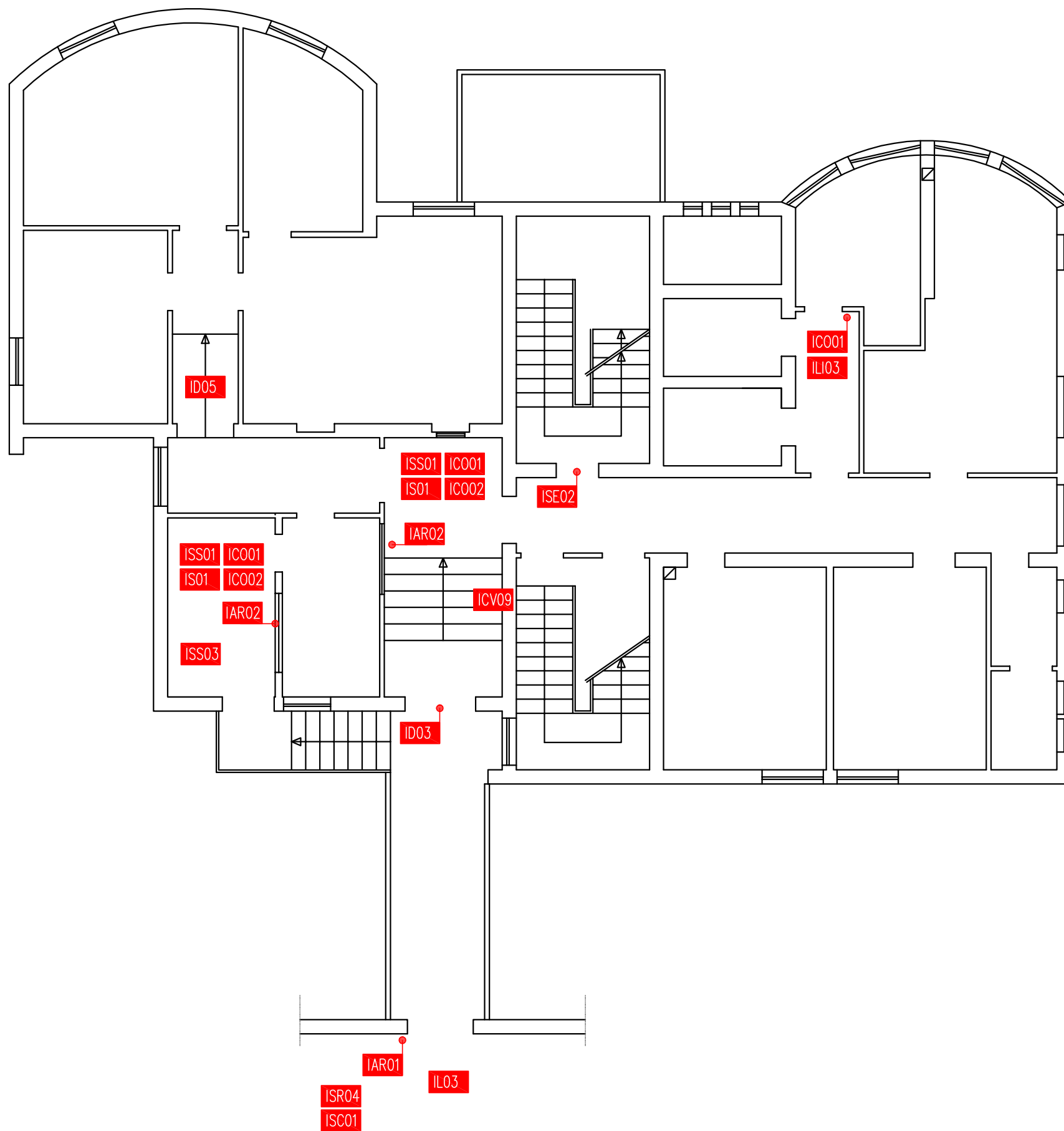

BBBA

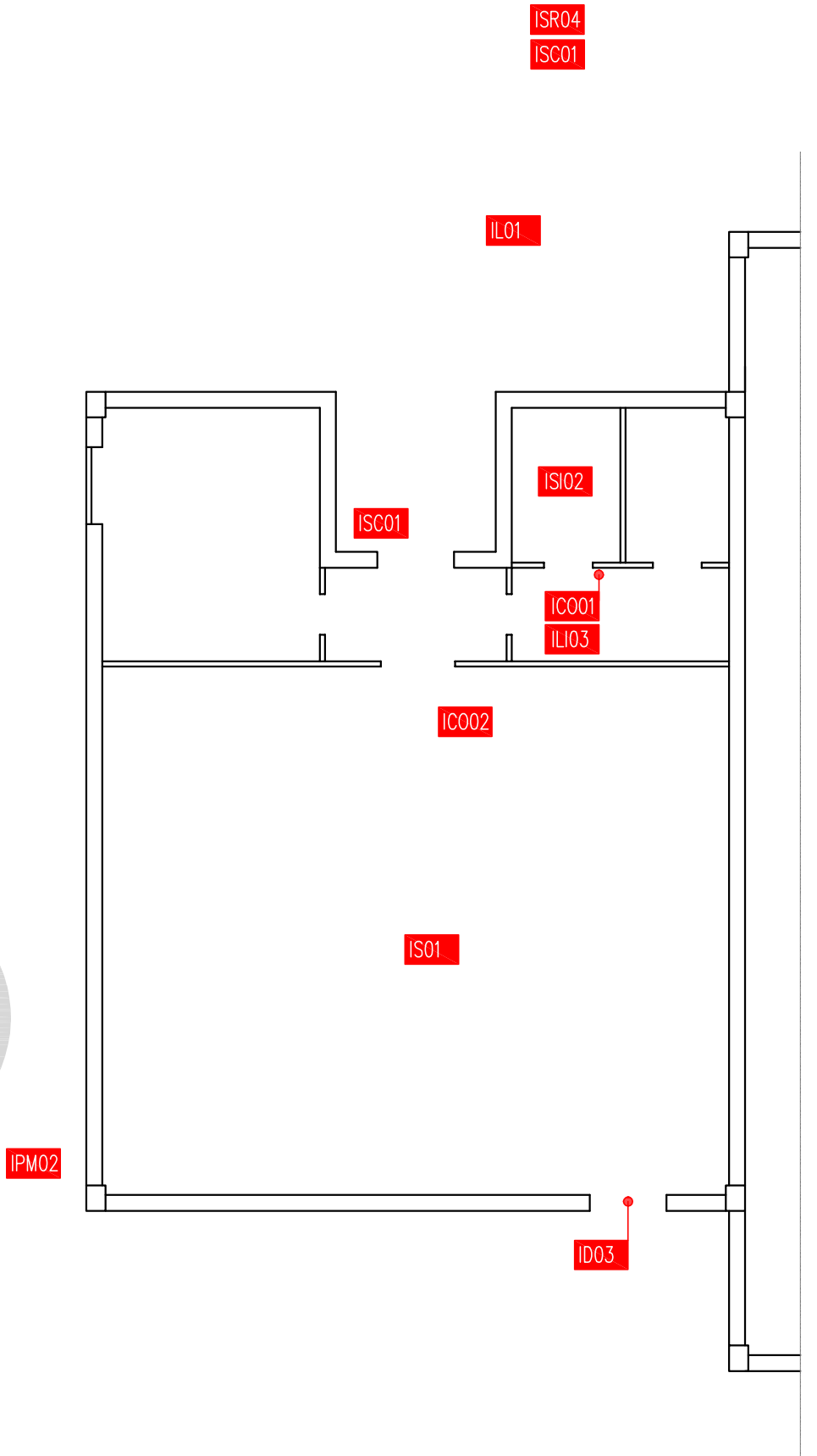

PROBABILE

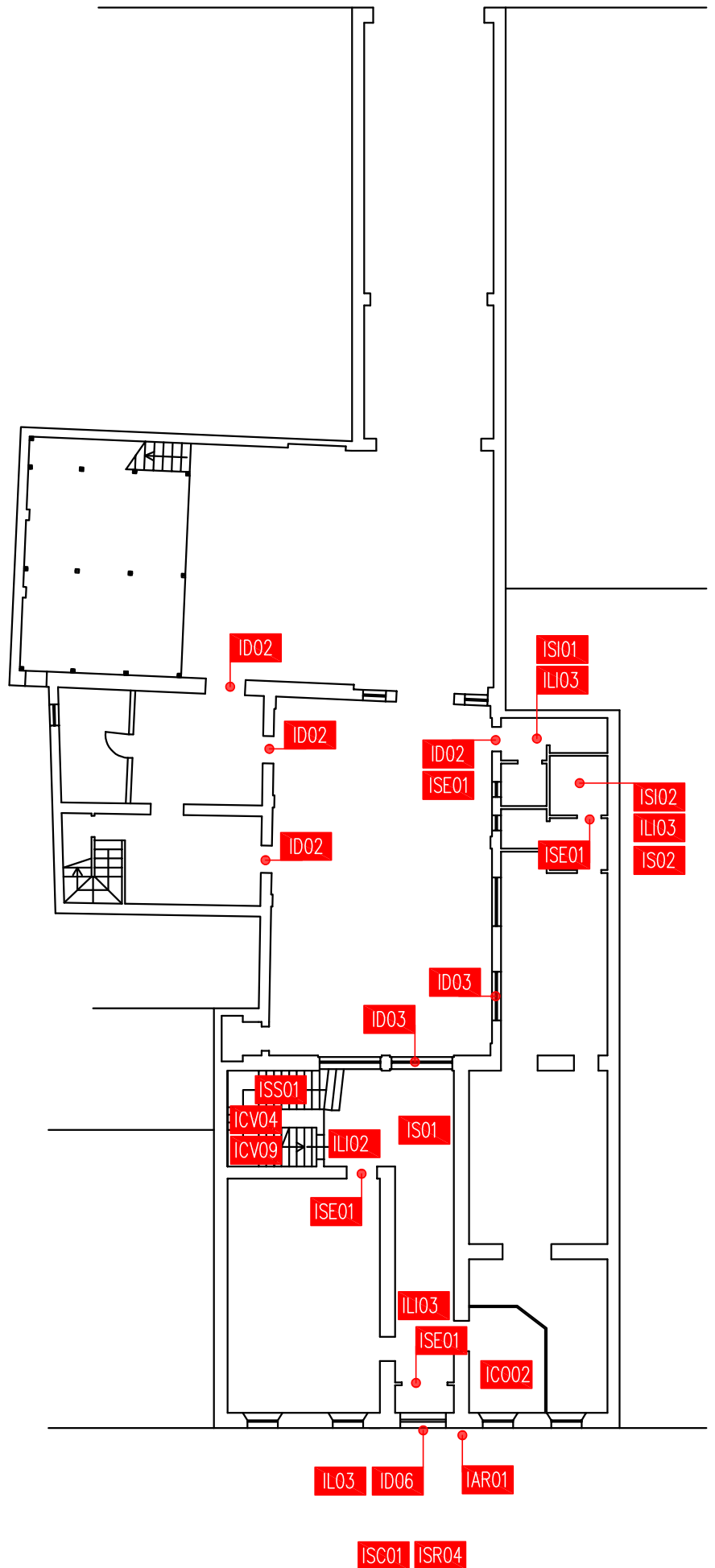

SEDE A.S.M.

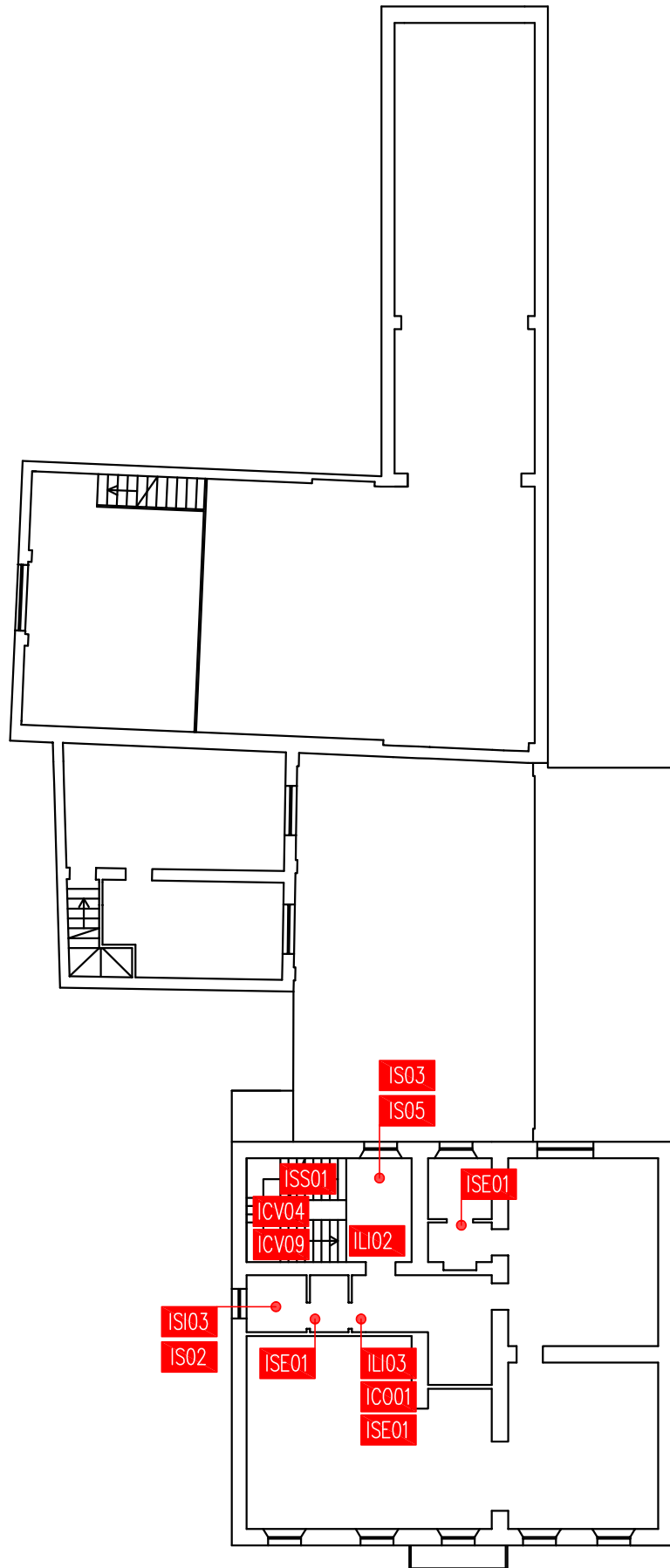

PIANO PRIMO

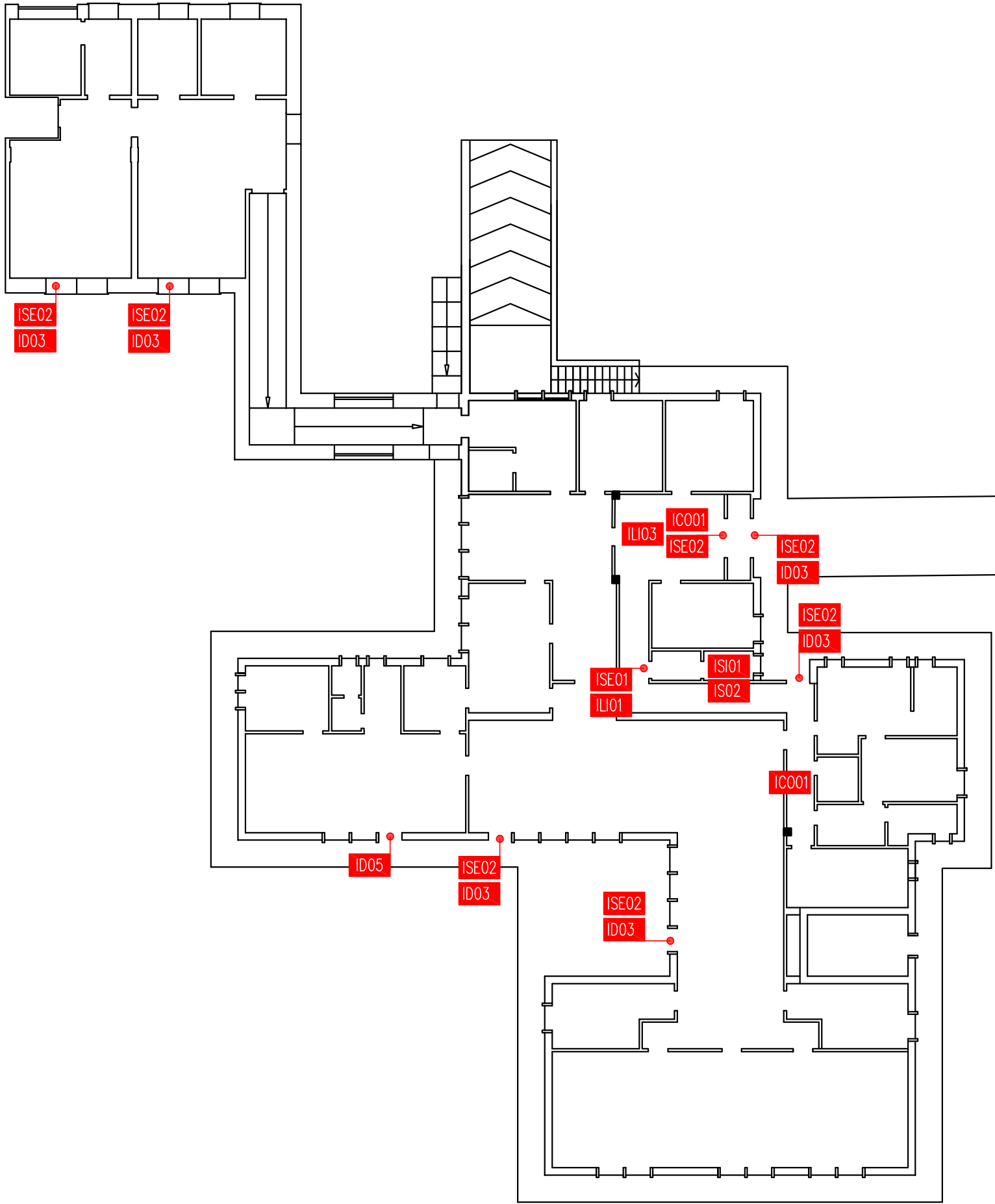

ISR04  
ID01  
IPM01

ISC01  
ILO3

ISE01  
IAR01

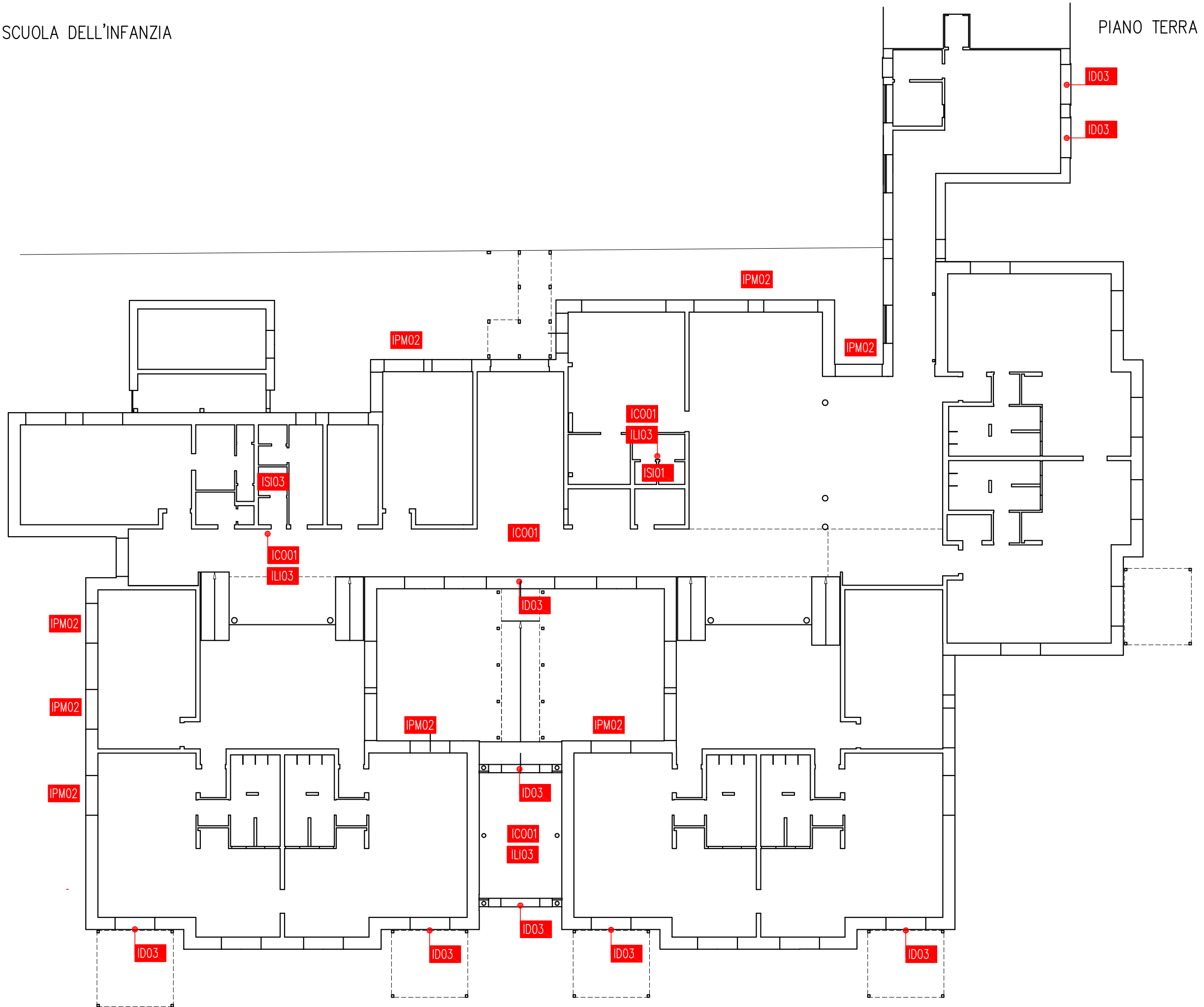

IPM01	ISC01
ID04	IL03



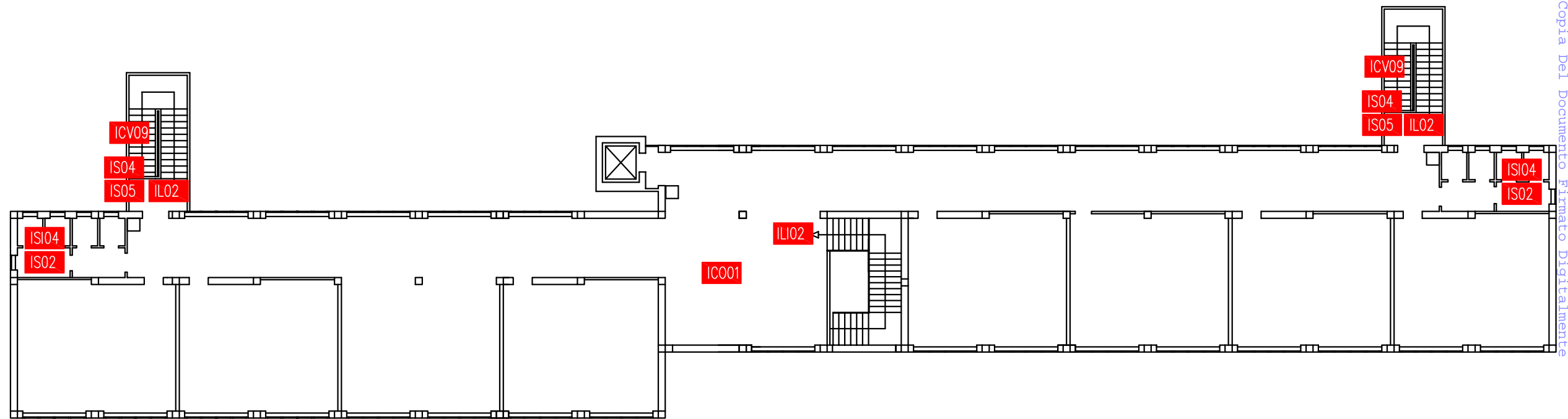

BBBA



BBBA

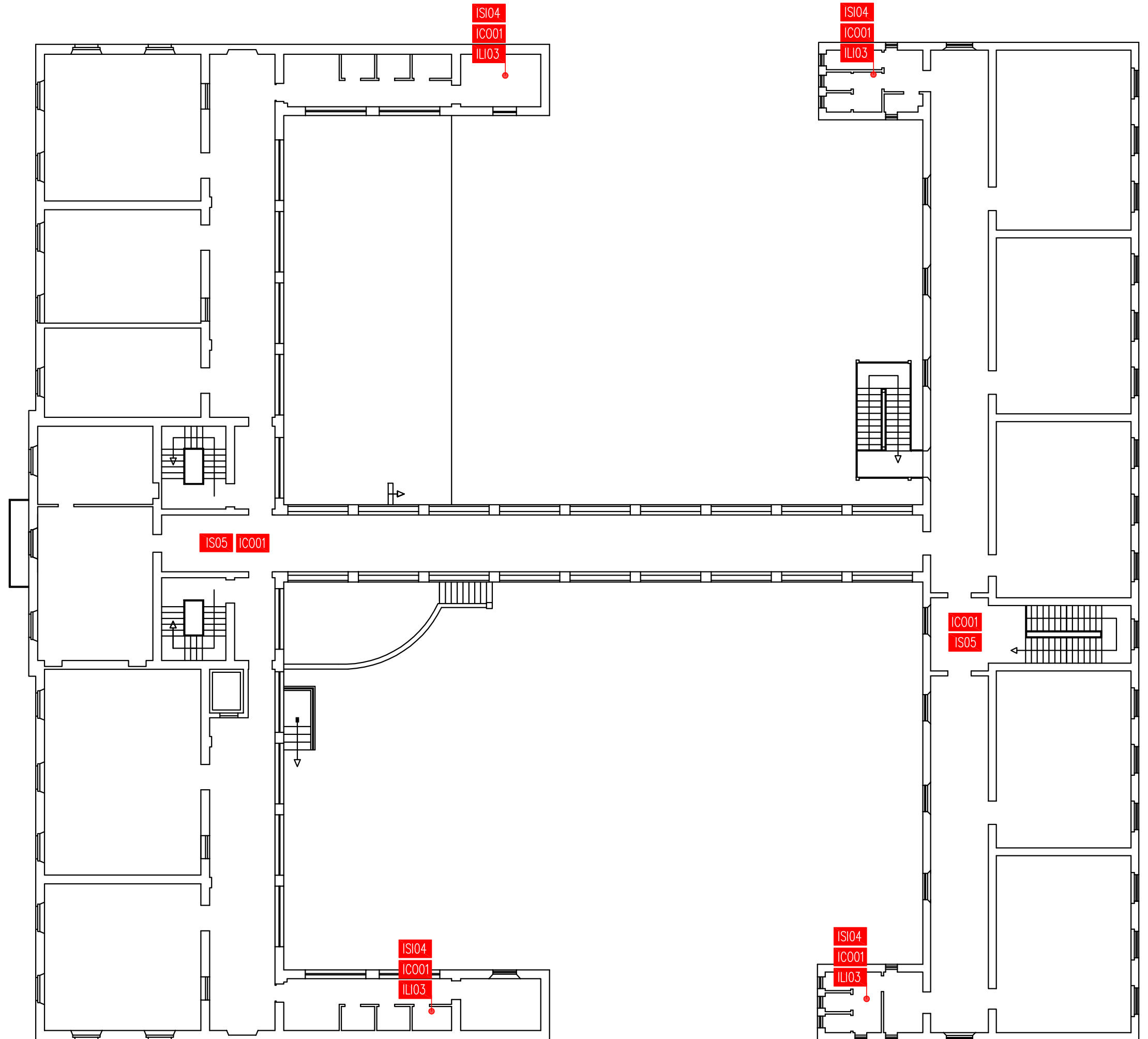



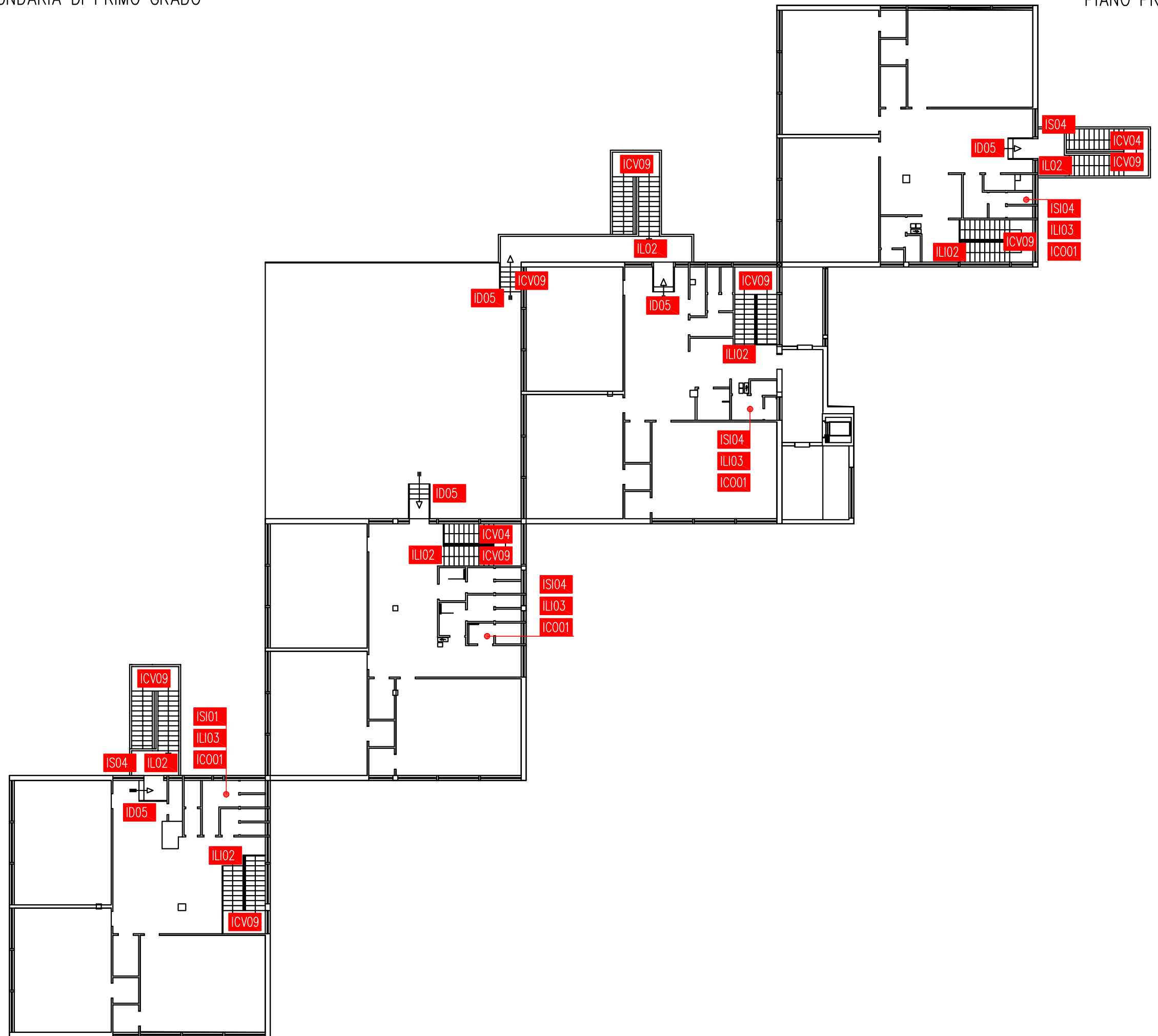

BBBA

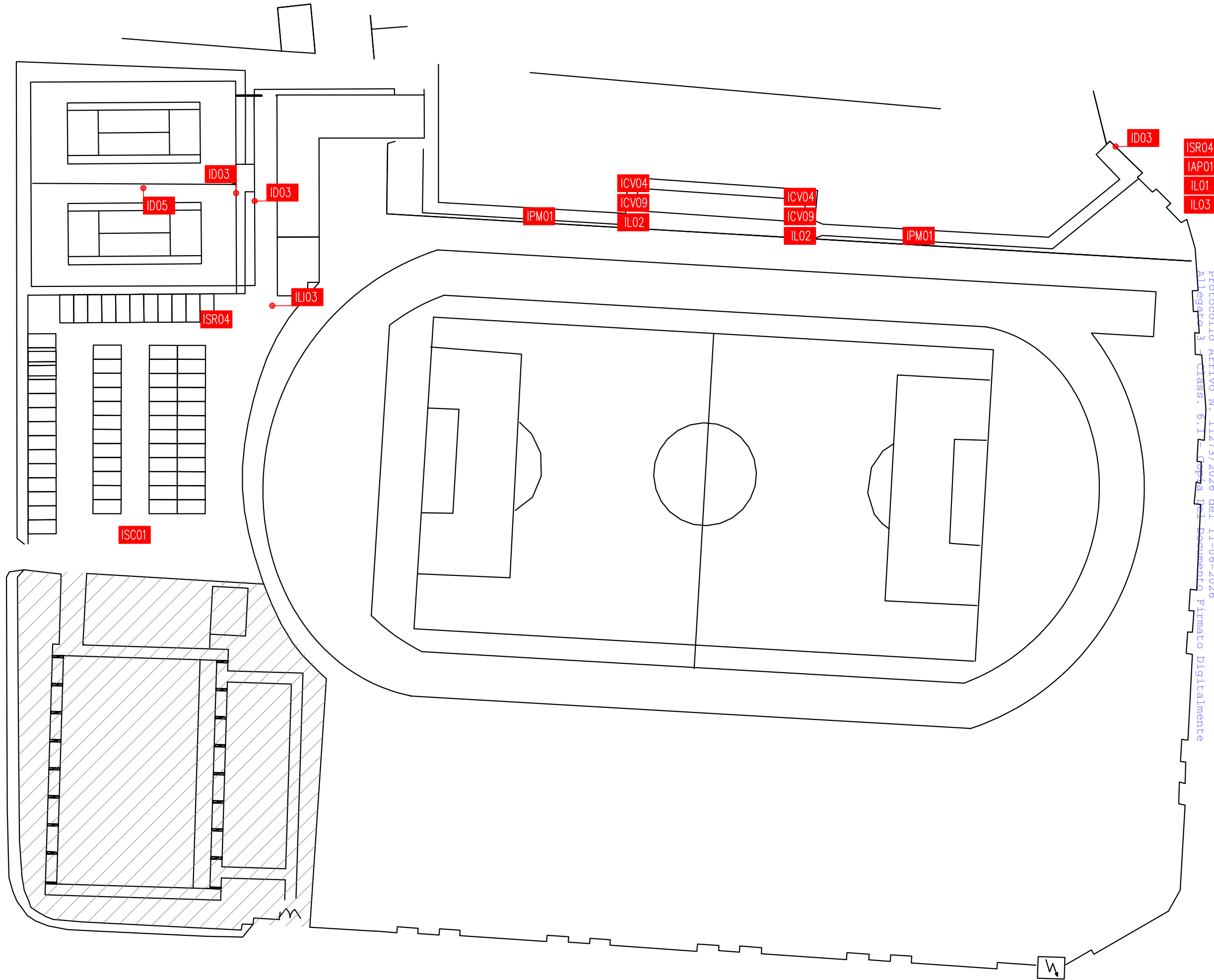

BBBA

BBBA



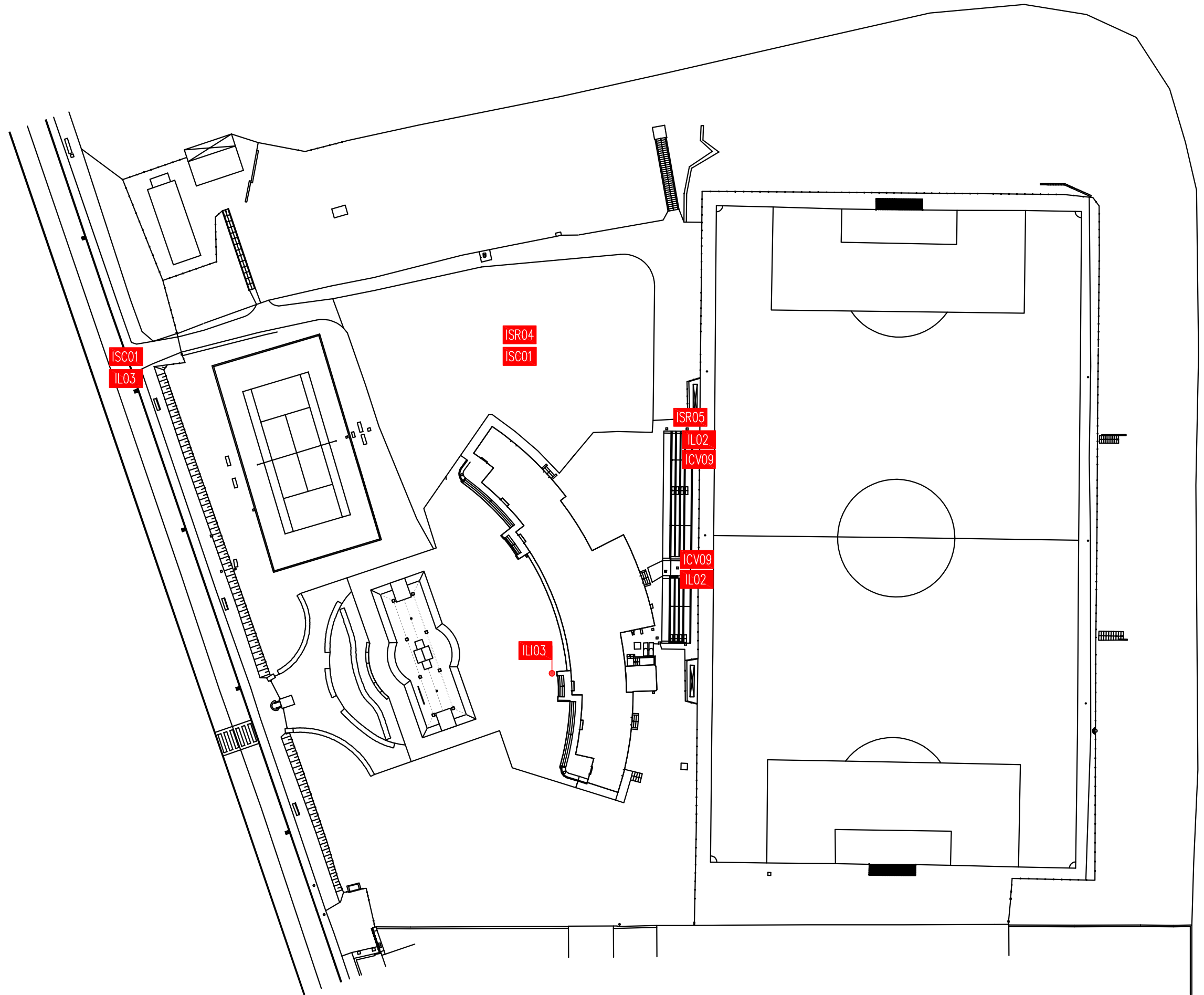

ARRETRATI



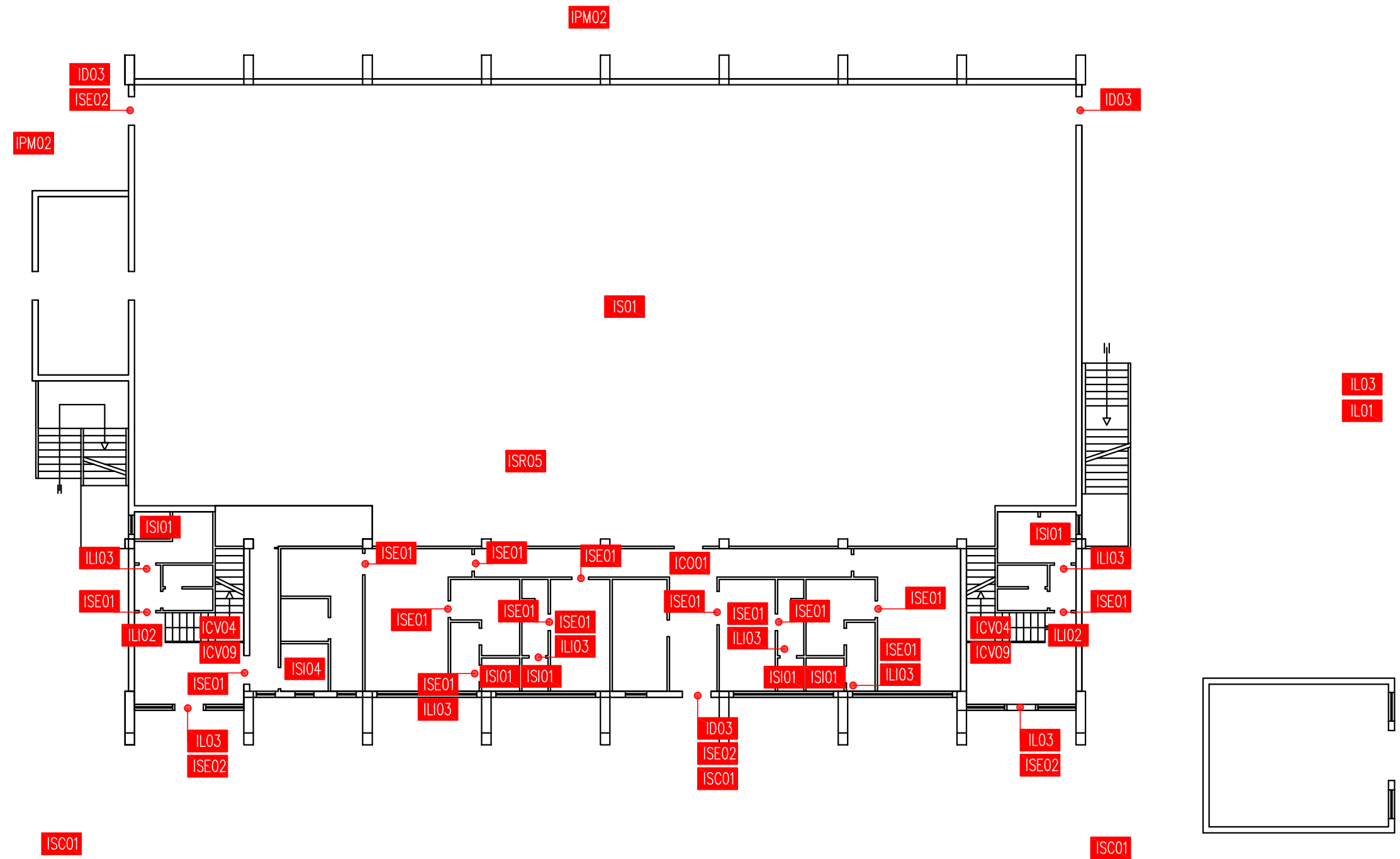

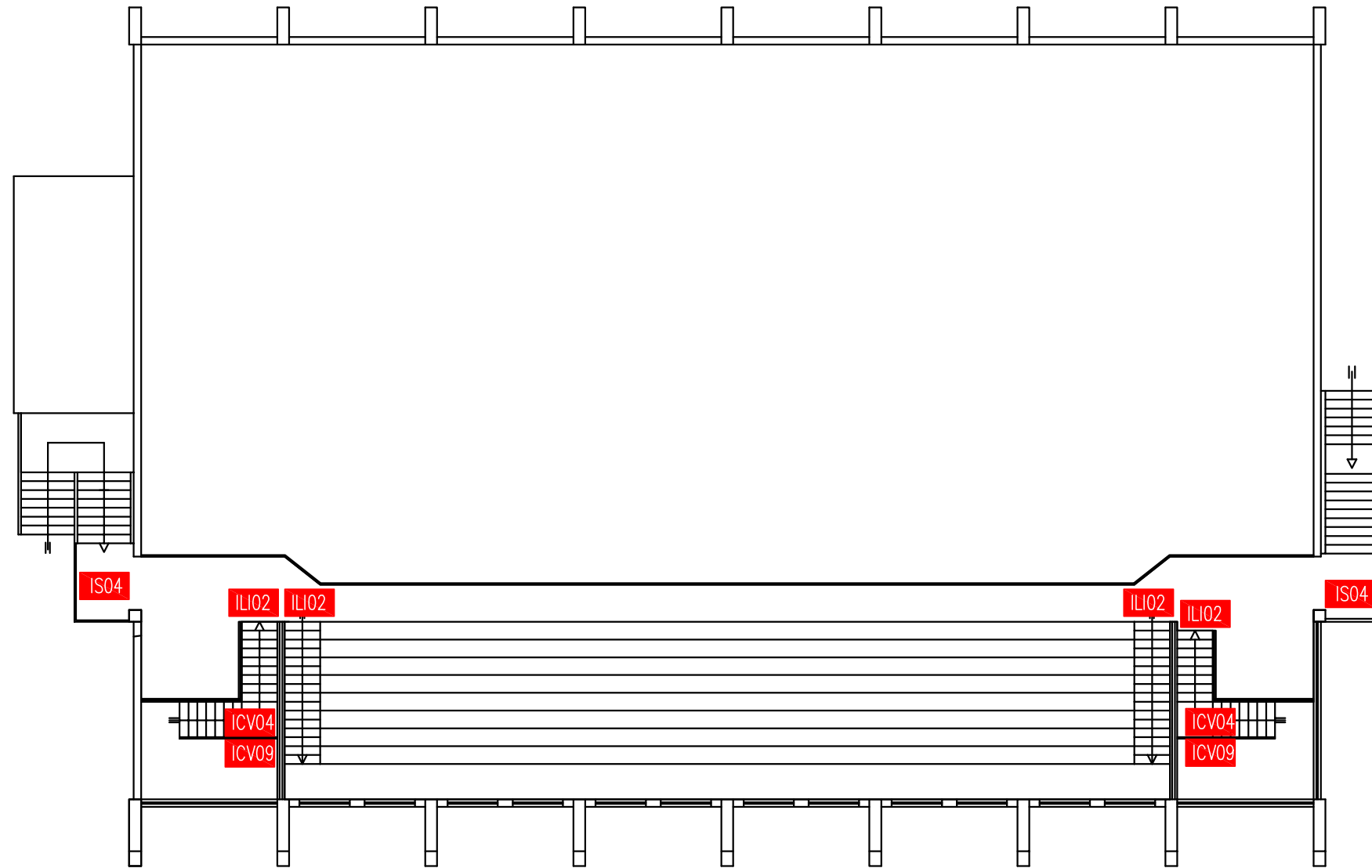

BBB  
A

BBBA

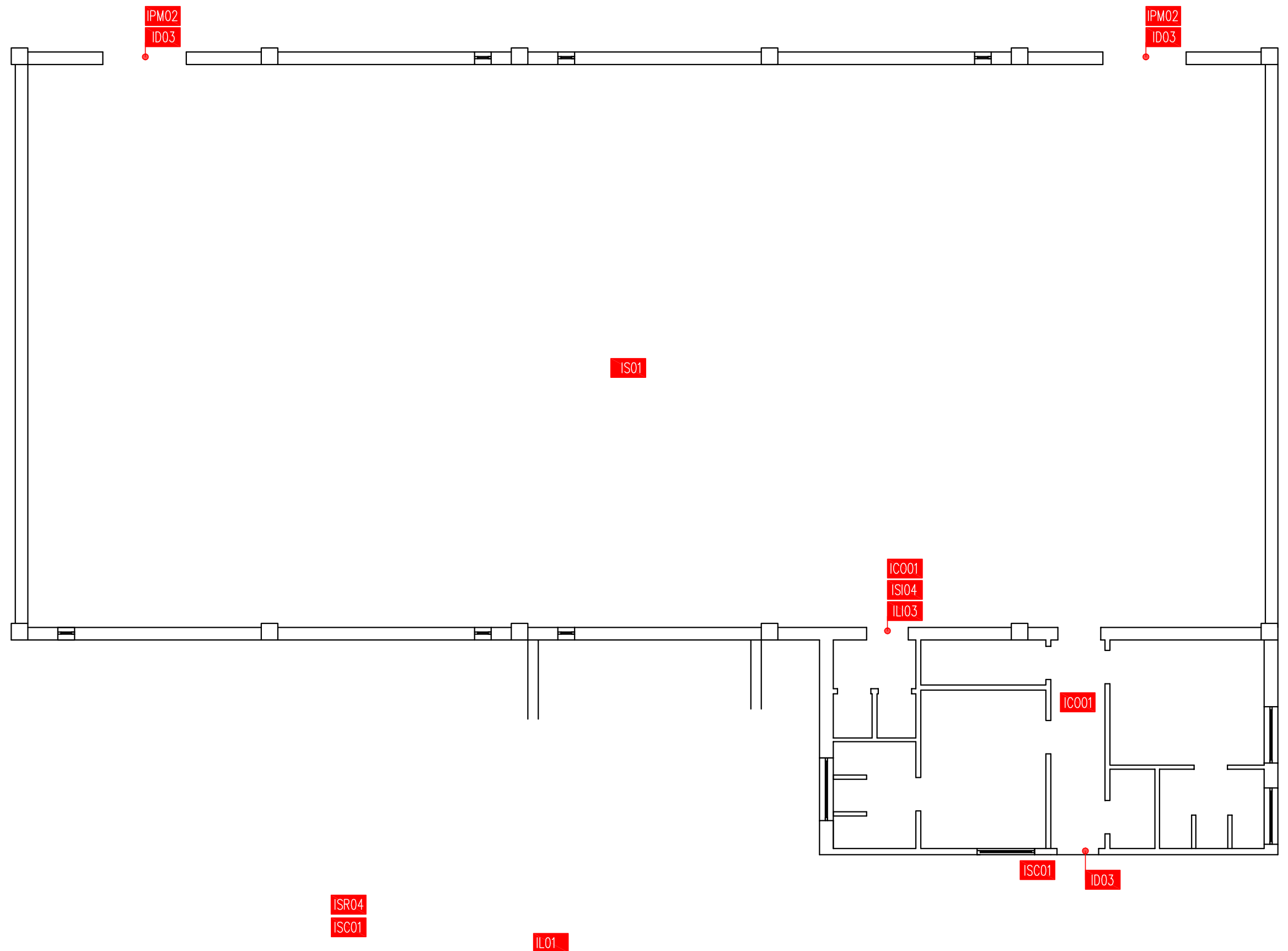

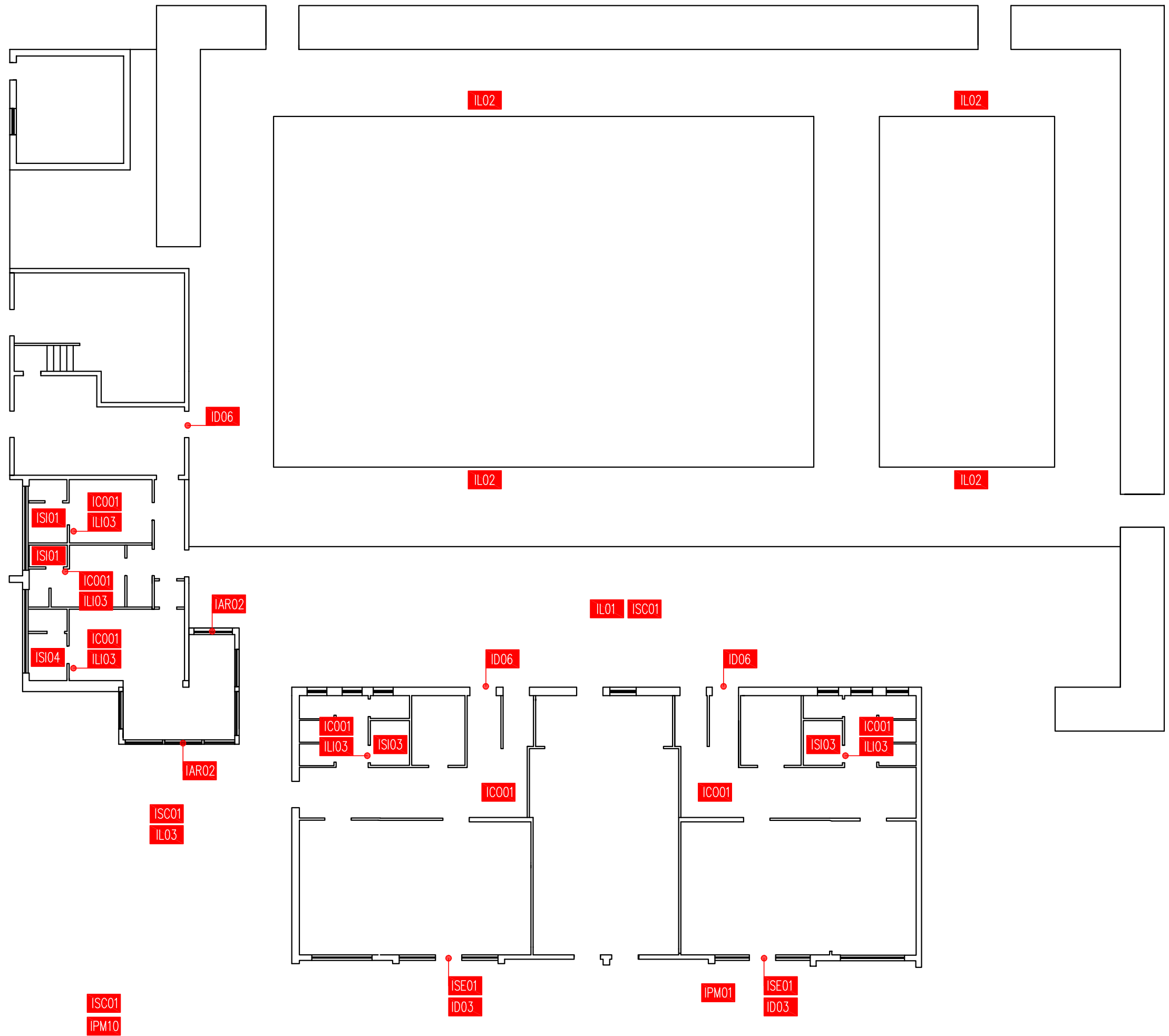

BBBA



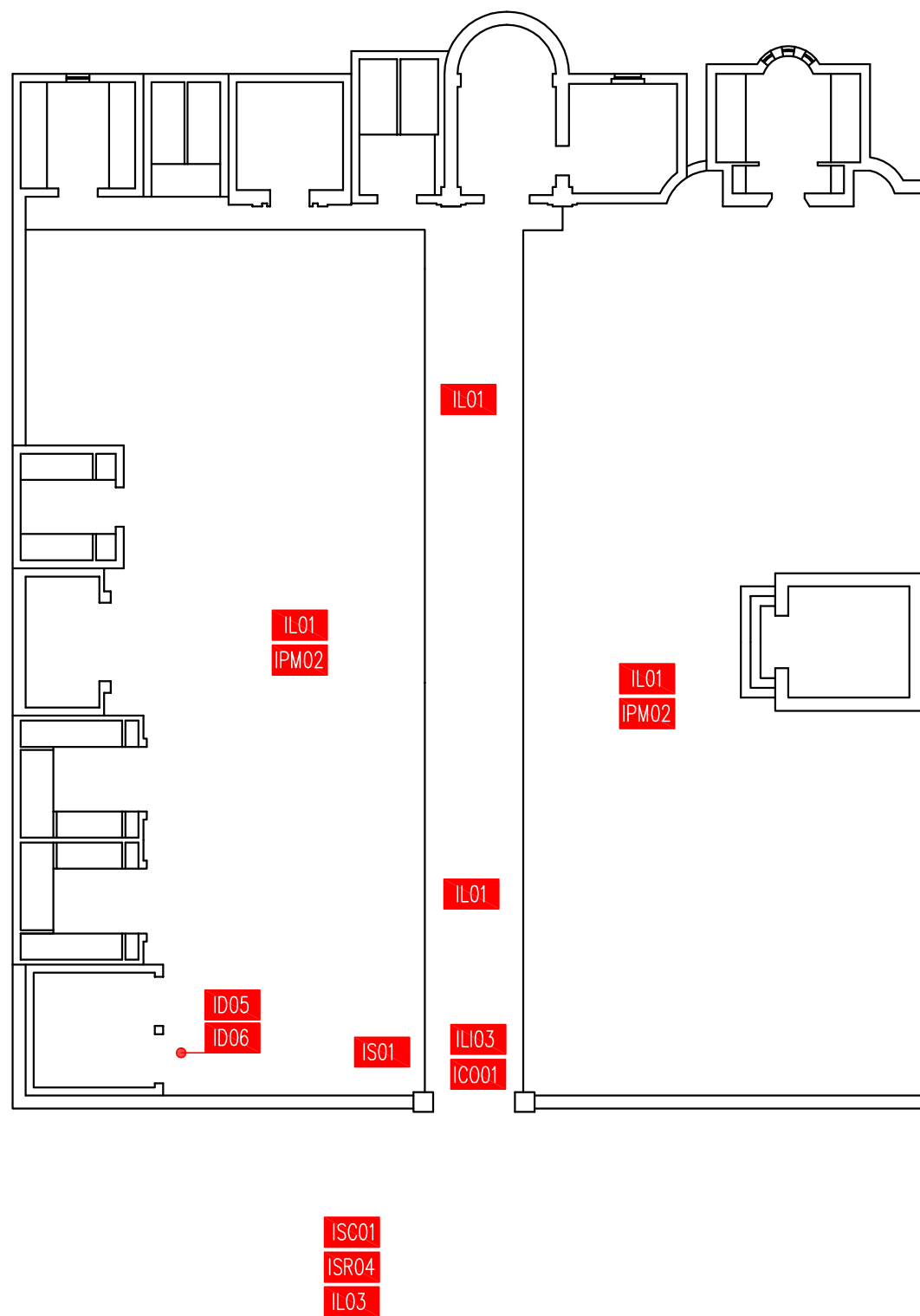

BBBA

BBBA

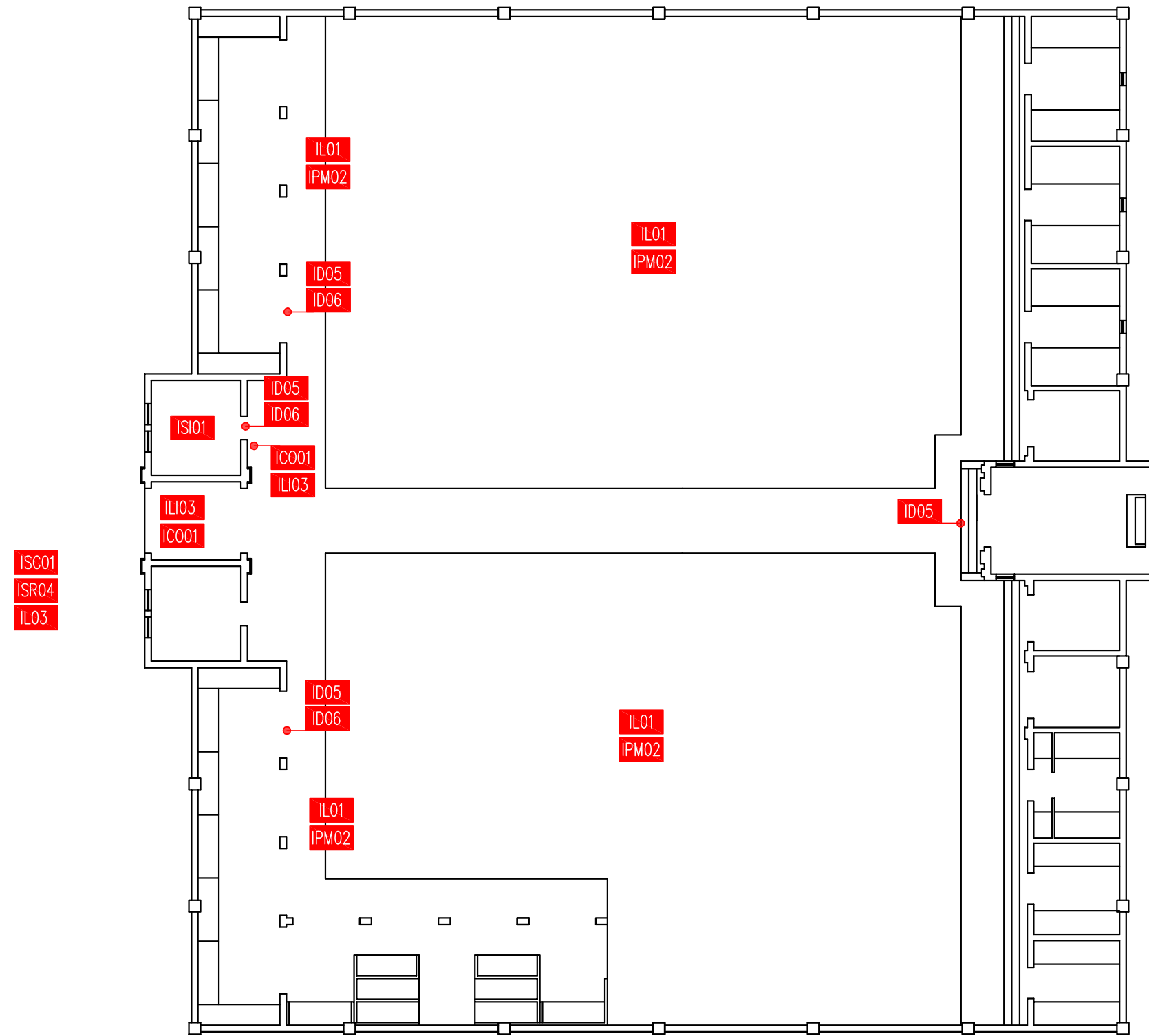

GIARDINI PIAZZA DELLA VITTORIA – PIAZZA TRIESTE

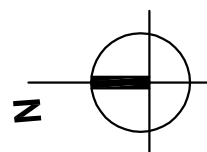
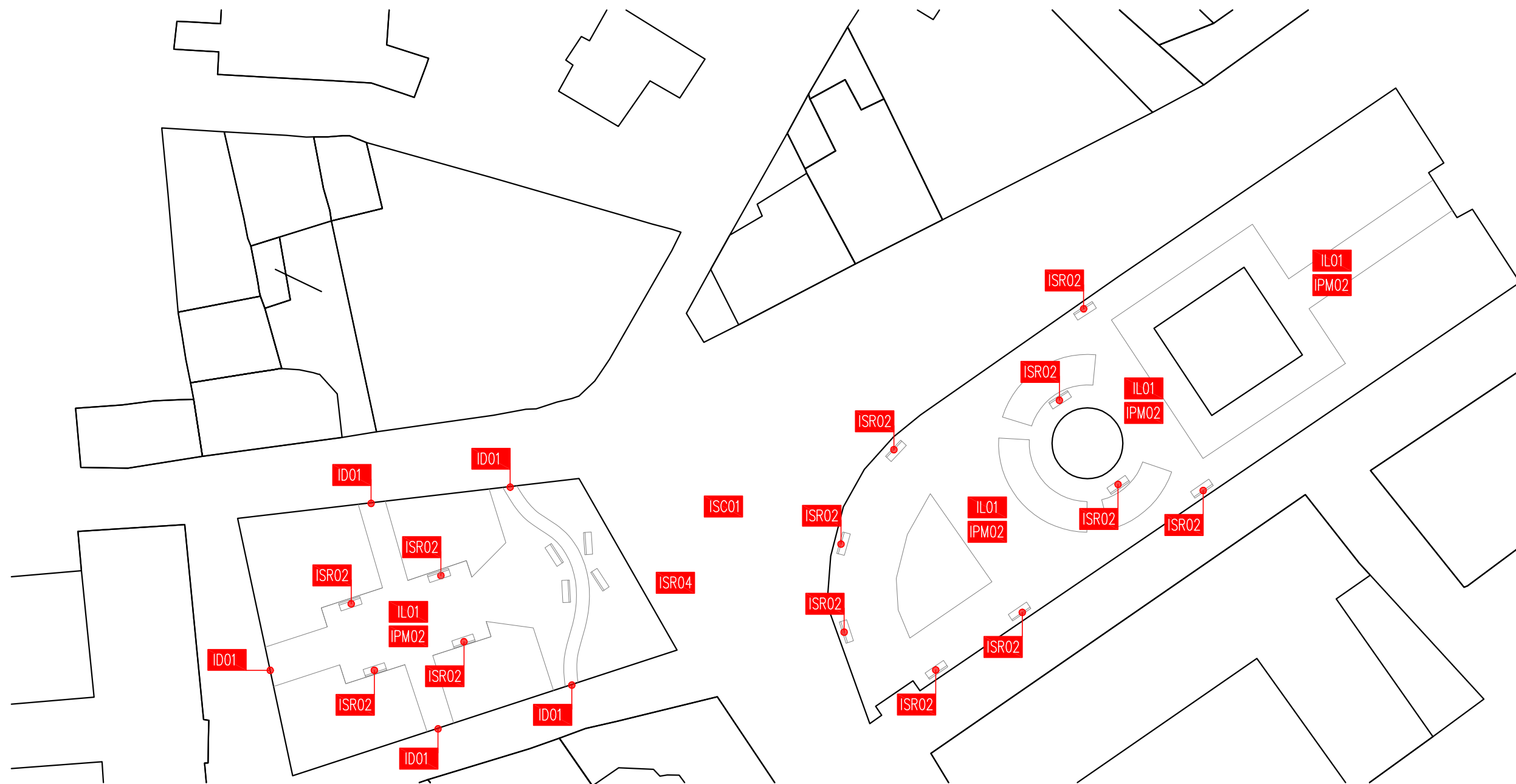

P  
E  
B  
A

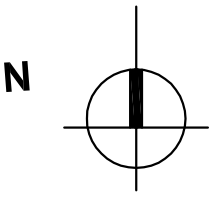

# PARCO GIOCHI VIA PONCHIELLI

PARCHEGGIO

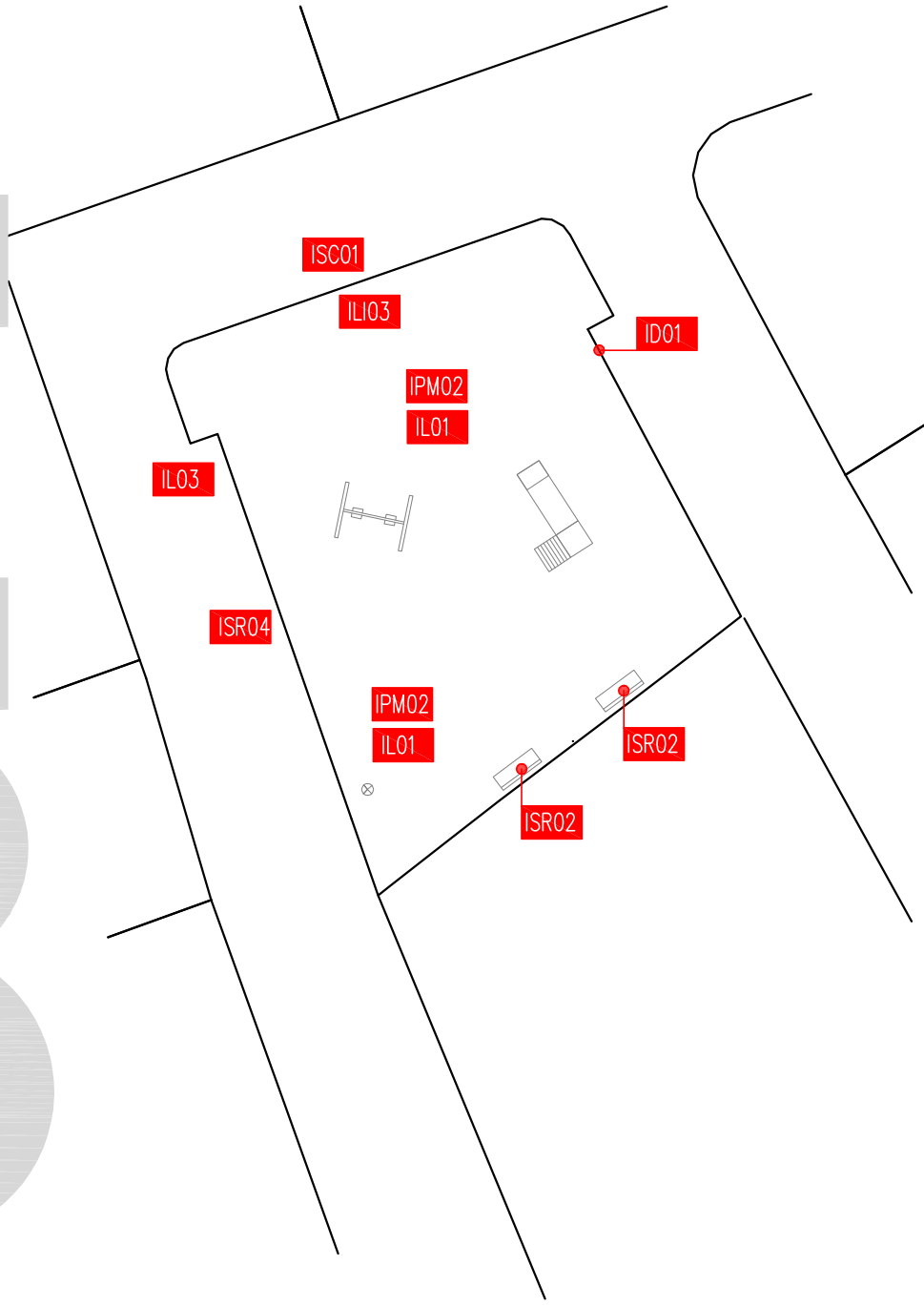

AOO COMUNE DI CASTELLEONE  
Protocollo Arrivo N. 11273/2026 del 11-06-2026  
Allegato 3 - Class. 6.1 - Copia Del Documento Firmato Digitalmente

# PARCO IN LOCALITA' LE VALLI

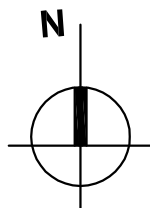
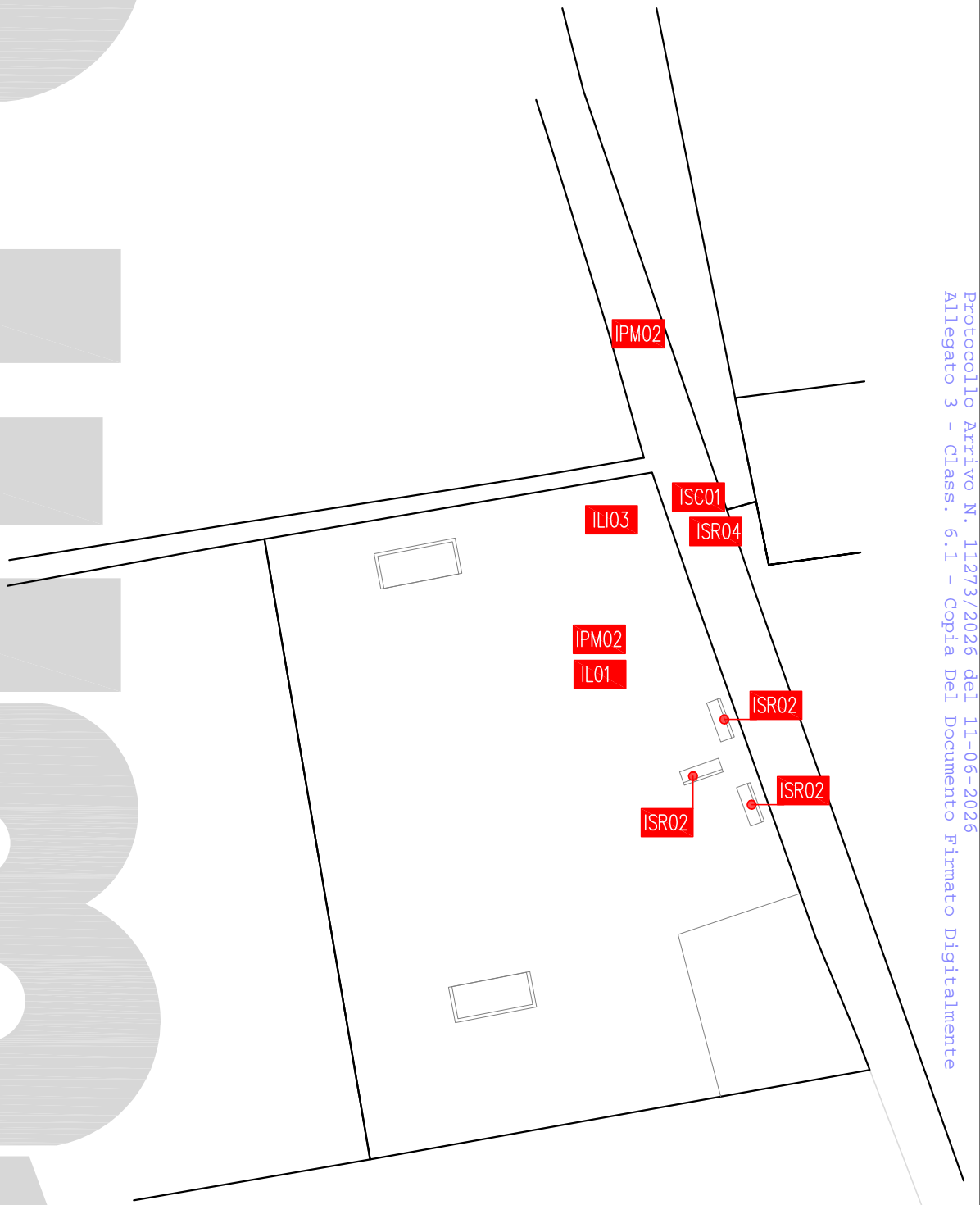

AOO COMUNE DI CASTELLEONE  
Protocollo Arrivo N. 11273/2026 del 11-06-2026  
Allegato 3 - Class. 6.1 - Copia Del Documento Firmato Digitalmente

PARCO  
LE  
VALLI

PARCO

PARCO DI VIA GRAMSCI

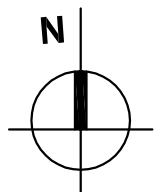
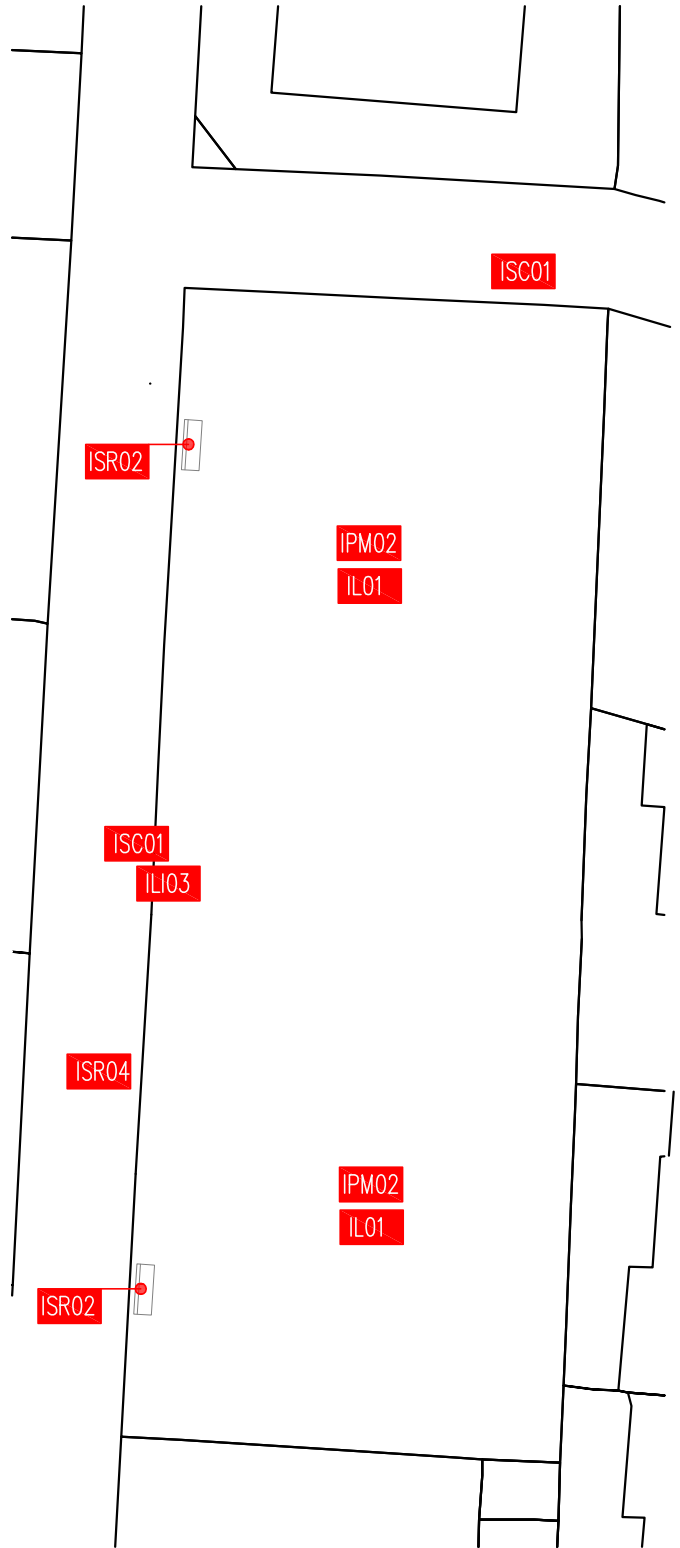

# PARCO DI VIA BECCHETTO

PARCO DI VIA BECCHETTO

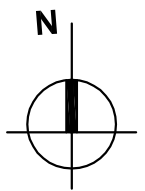

AOO COMUNE DI CASTELLEONE  
Protocollo Arrivo N. 11273/2026 del 11-06-2026  
Allegato 3 - Class. 6.1 - Copia Del Documento Firmato Digitalmente

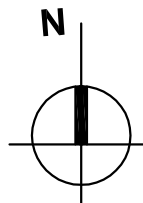
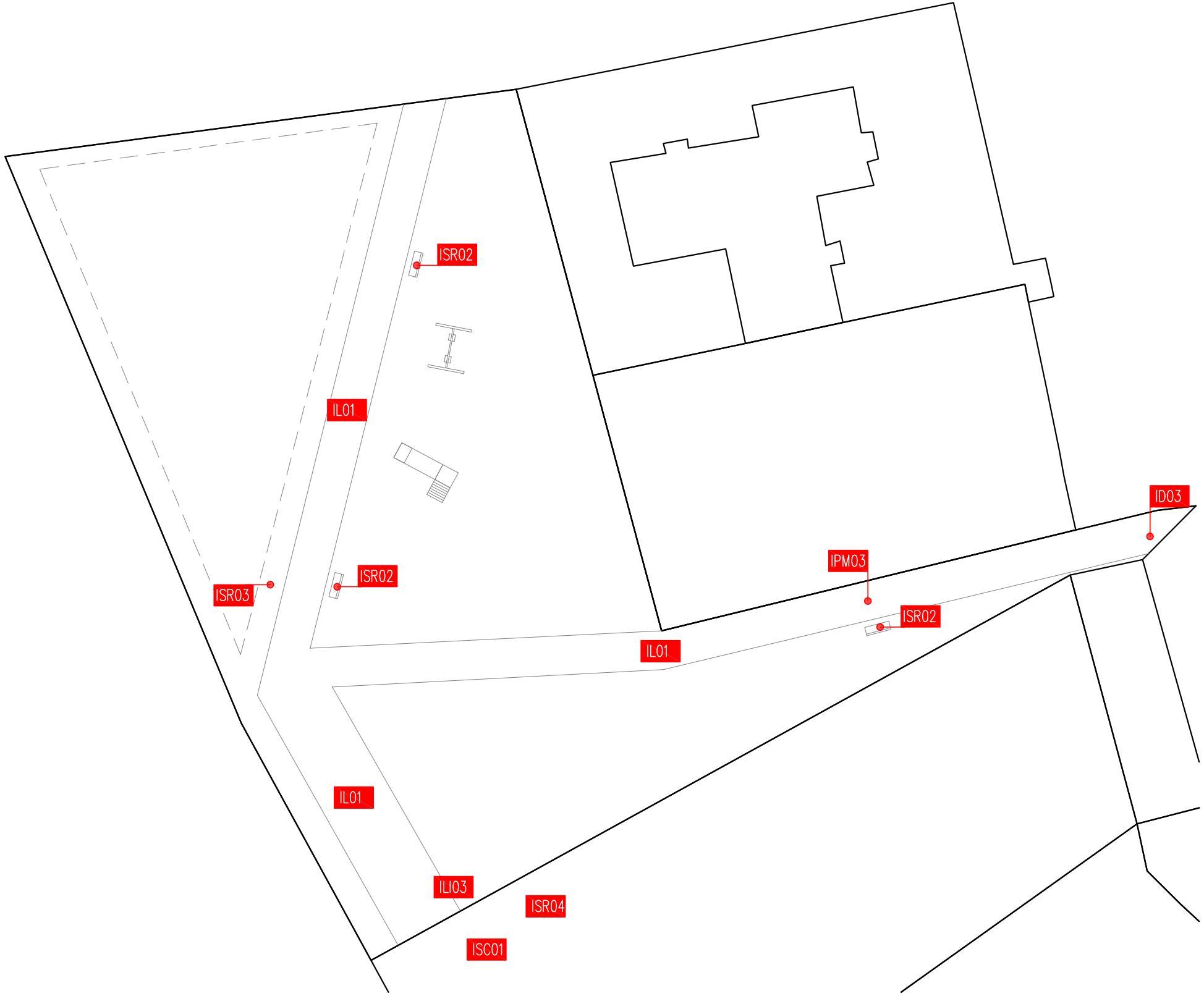

# PARCO MATTEOTTI

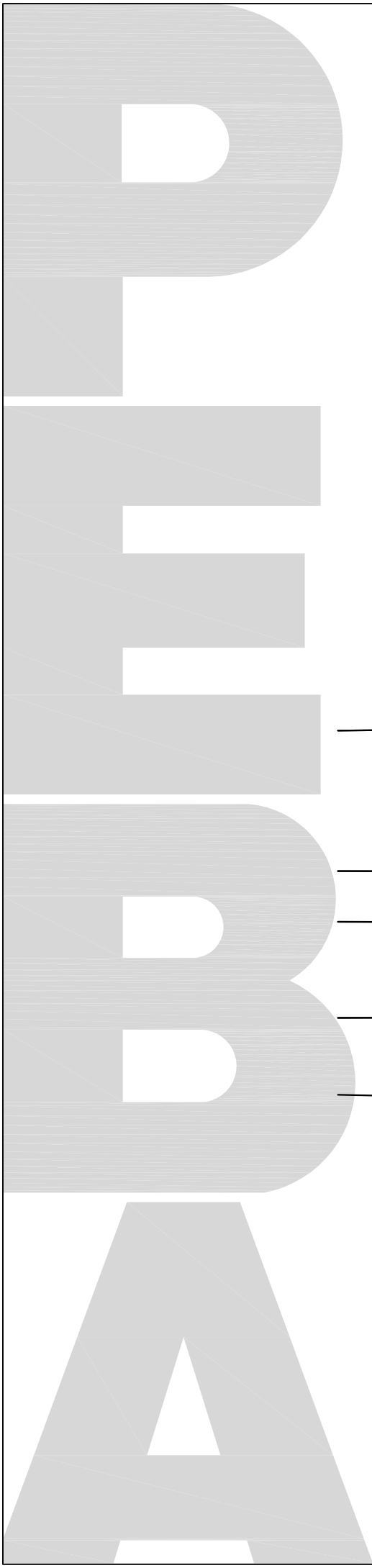
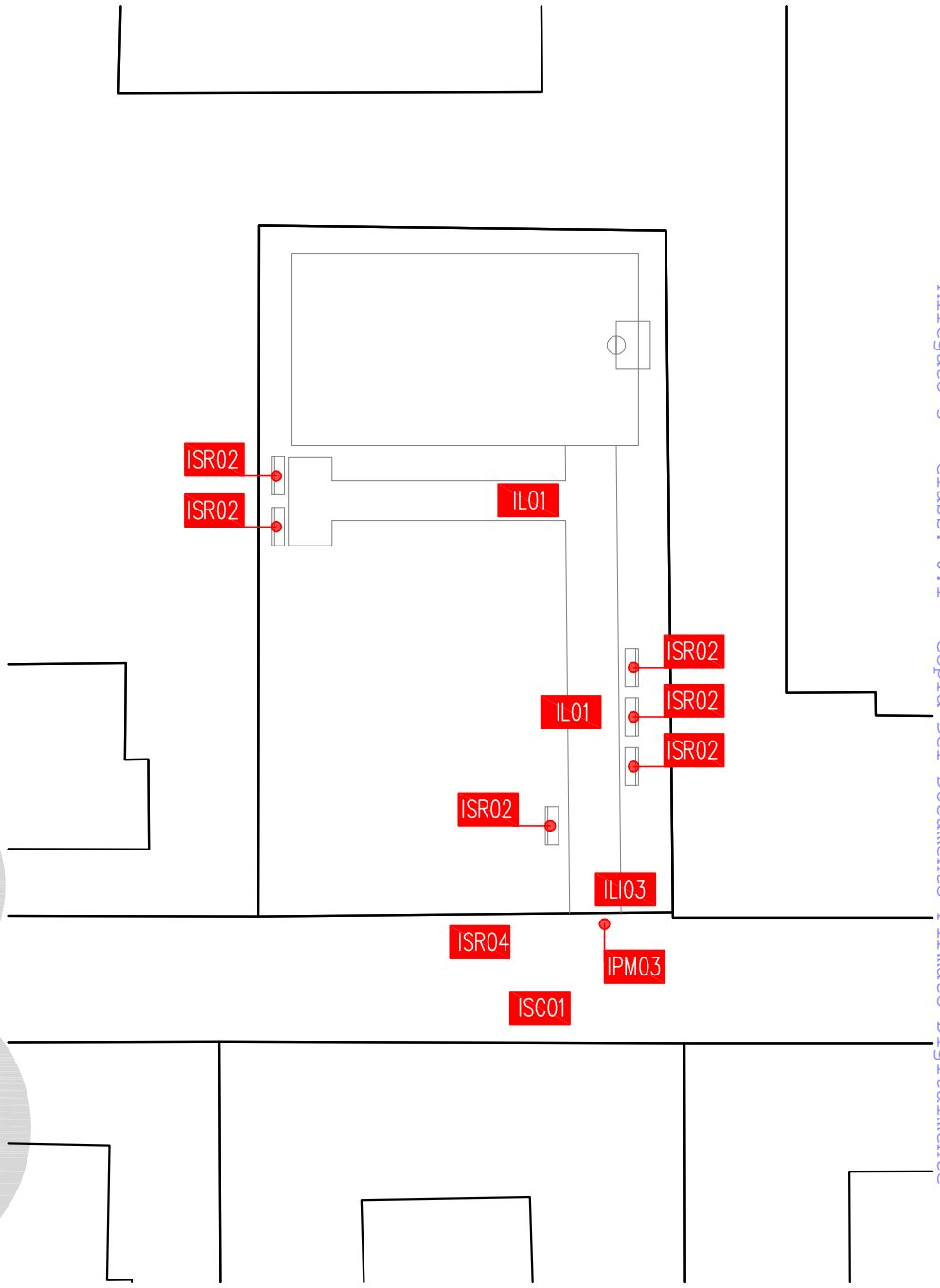

# PARCO VIA I MAGGIO

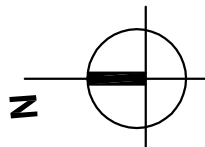
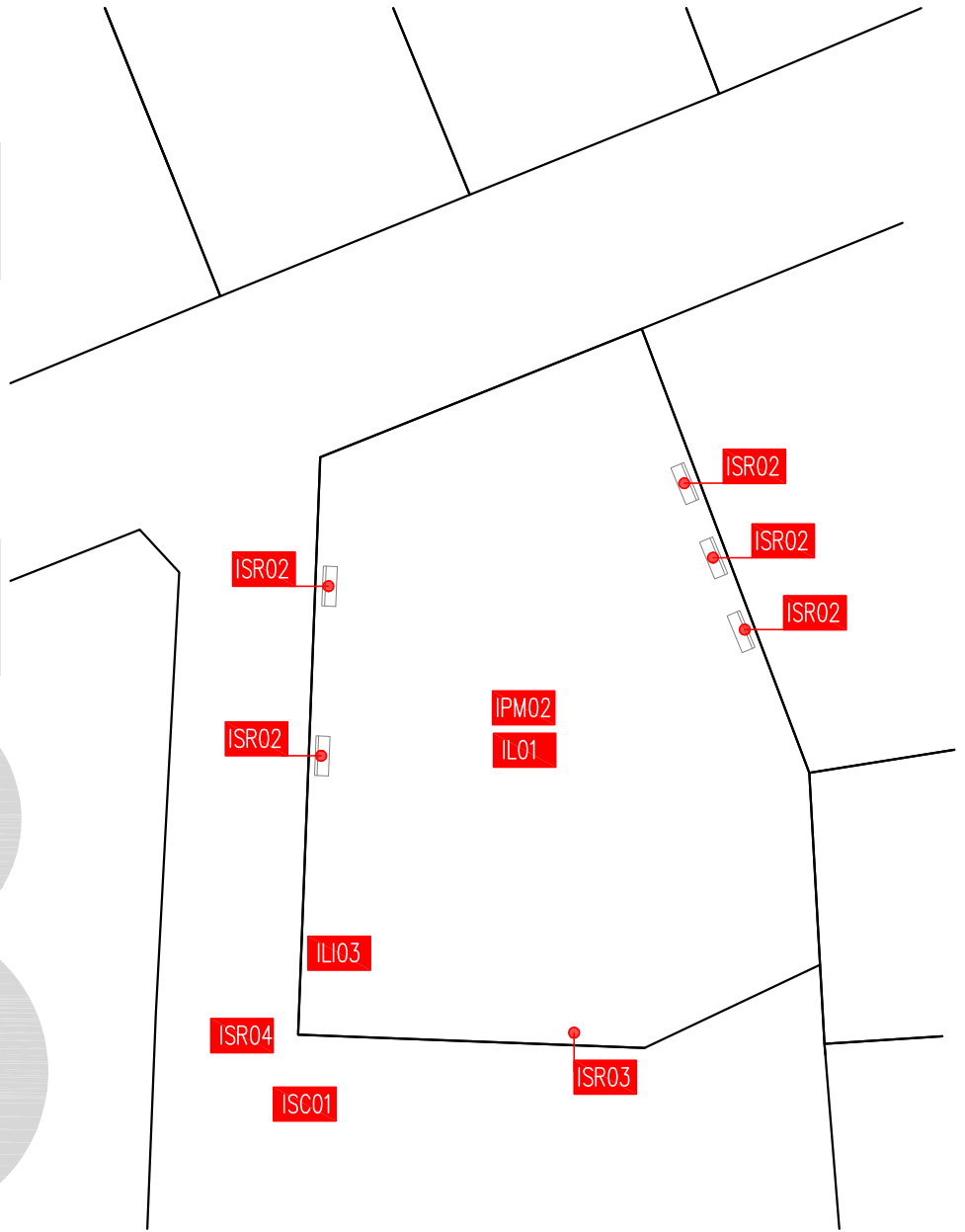

PARCO

# PARCO VIA FULCHERIA

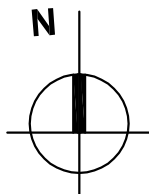

PARCO  
VIA  
FULCHERIA